

FEATURES

- Carbon resistive element.
- Dust proof enclosure.
- Polyester substrate.
- Also upon request:
 - Wiper positioned at 50% or fully clockwise.
 - Long life model for low cost control pot. applications
 - Low torque option
 - Supplied in magazines for automatic insertion.
 - Self extinguishable plastic UL 94V-0
 - Cut track option
 - Special Tapers
 - Mechanical detents

MECHANICAL SPECIFICATIONS

- Mechanical rotation angle: $265^\circ \pm 5^\circ$
 $240^\circ \pm 5^\circ$ available under drawing (blue housing only)
- Electrical rotation angle: $240^\circ \pm 20^\circ$
- Torque: 0.5 to 2.5 Ncm.
(0.7 to 3.4 in-oz)
- Stop torque: > 10 Ncm. (> 14 in-oz)
- Life: up to 200K cycles

ELECTRICAL SPECIFICATIONS

- Range of values (*)
 $100\Omega \leq R_n \leq 5\text{ M}$ (Decad. 1.0 - 2.0 - 2.2 - 2.5 - 4.7 - 5.0)
- Tolerance (*): $100\Omega \leq R_n \leq 1\text{M}\Omega$ $\pm 20\%$
 $1\text{M}\Omega < R_n \leq 5\text{M}$ $\pm 30\%$
- Max. Voltage: 250 VDC (lin) 125 VDC (no lin)
- Nominal Power 50°C (122°F) (see power rating curve)
0.25 W (lin) 0.12 W (no lin)
- Taper (*) (Log. & Alog. only $R_n \geq 1\text{K}$) Lin ; Log; Alog.
- Residual resistance(*): $\leq 0.5\%$ R_n (5Ω min.)
- Equivalent Noise Resistance: $\leq 3\%$ R_n (3Ω min.)
- Operating temperature**: $-25^\circ\text{C} + 70^\circ\text{C}$ ($-13^\circ\text{F} + 158^\circ\text{F}$)

* Others upon request

** Up to 85°C depending on application

HOW TO ORDER

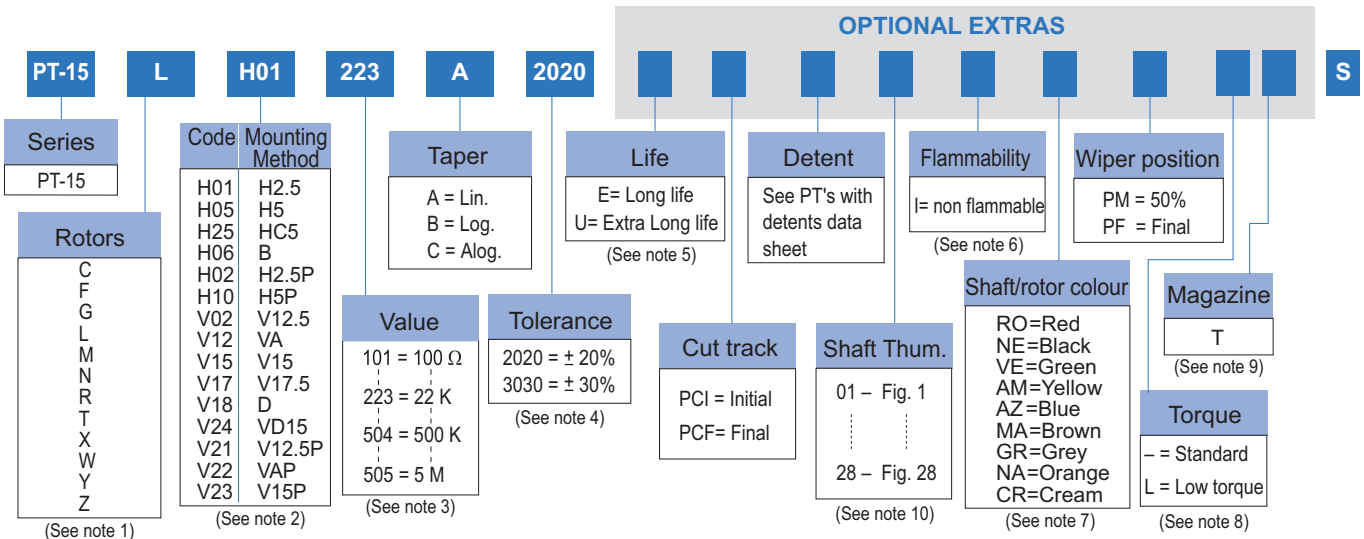

NOTES:

- (1) "Z" adjustment only available on "H" versions. Standard colour for the "T" rotor: Orange
- (2) Terminal styles: "P" are crimped terminals. V24 not available with steel terminals. V=Vertical adjust; H=Horizontal Adjust
- (3) Value Example: Code: $\overset{10}{\text{10}} \overset{1}{\text{1}} \overset{\text{1}}{\text{1}}$ 100 Ω
 → Num of zeros
 → First two digits of the value.
- (4) Non standard tolerance, upon request. Example: +7% Code: $\overset{07}{\text{07}} \overset{05}{\text{05}}$
 → negative tolerance
 → positive tolerance
- (5) Life
 - Standard 500 cycles
 - Long life 10000 cycles
 - Extra Long life 100000 cycles (to be studied case by case)
- (6) Non flammable: housing, rotor and shaft. According to UL 94V-0
- (7) Colour shaft/rotor:
 - Potentiometer without shaft: only rotor
 - Potentiometer with shaft: only shaft
 - Cream colour only available in standard plastic
- (8) Low Torque: $\leq 1.5\text{Ncm}$. *No detent option available for low torque models*
- (9) Magazines (35 pcs/mag): available for VA (12.5), V (12.5), V (12.5P), V (15), V15 (P) and H models.
For more information please contact your nearest Piher supplier.
- (10) If you wish to use your own custom plastic shaft/knob/actuator please contact Piher for advice about compatible materials.

NOTE: The information contained here should be used for reference purposes only.

HOW TO ORDER CUSTOM DRAWING

PT-15 LH 01 + DRAWING NUMBER (Max. 16 digits)

This way of ordering should be used for options which are not included in the "How to order" standard and optional extras.

STANDARD OPTIONS

Cut track	No
Detents	None
Non flammable	No
Rotor colour	White
Shaft colour	Natural
Wiper position	Initial
Torque	Standard

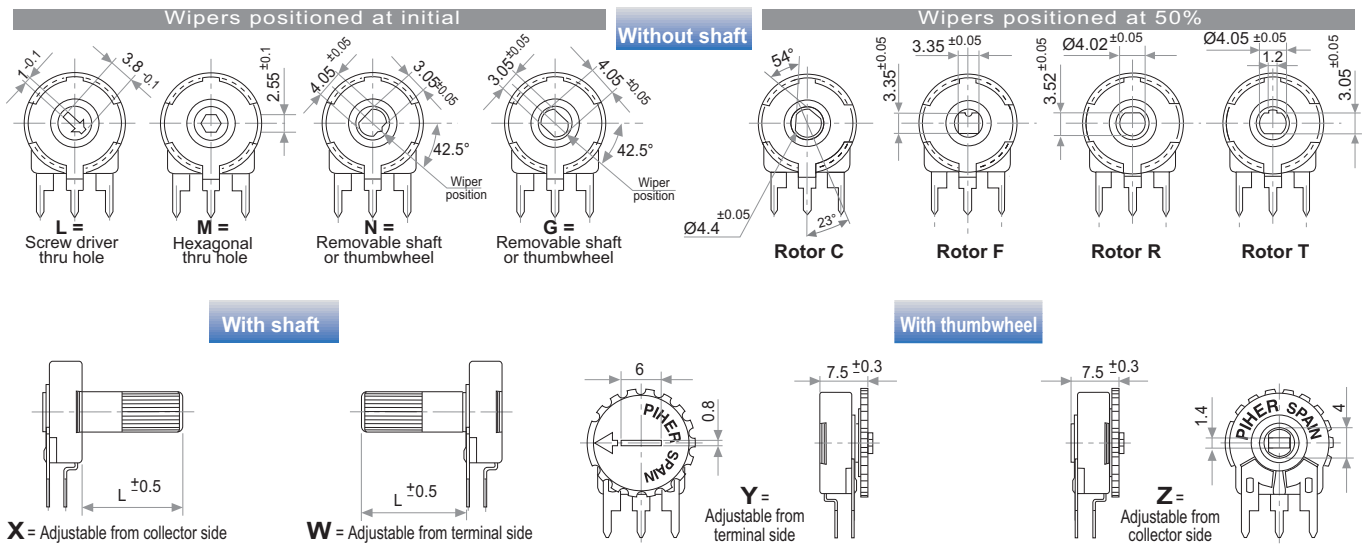

VERTICAL MOUNT - HORIZONTAL ADJUST

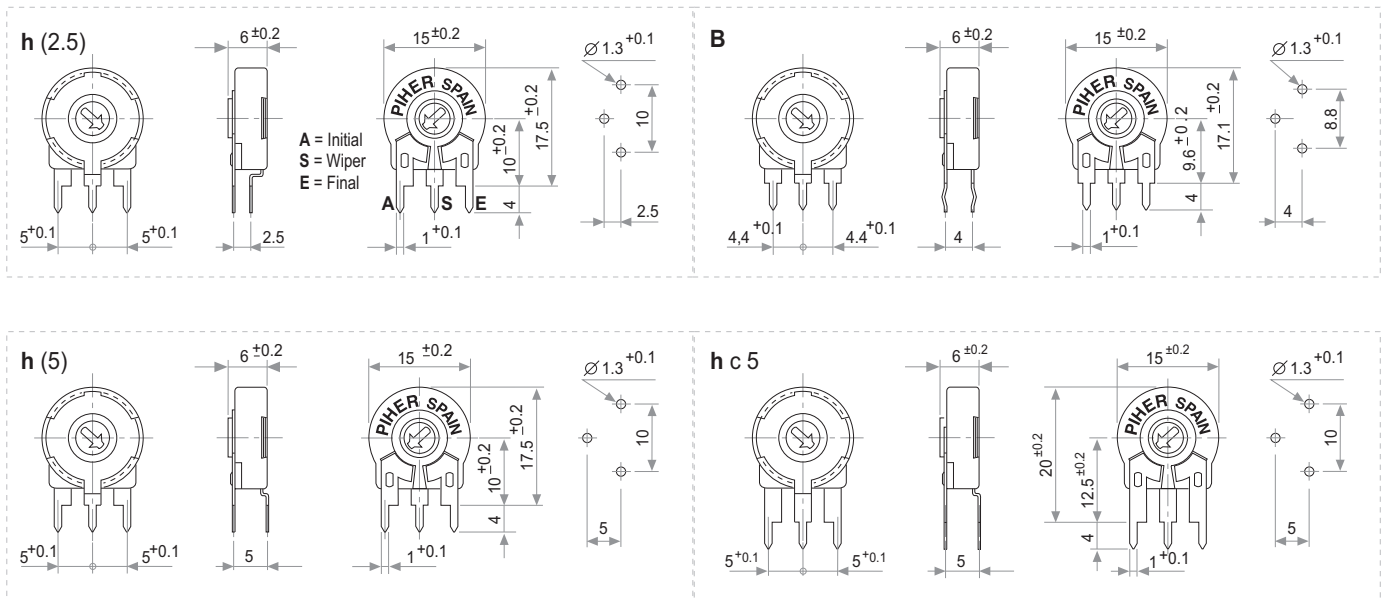

HORIZONTAL MOUNT - VERTICAL ADJUST

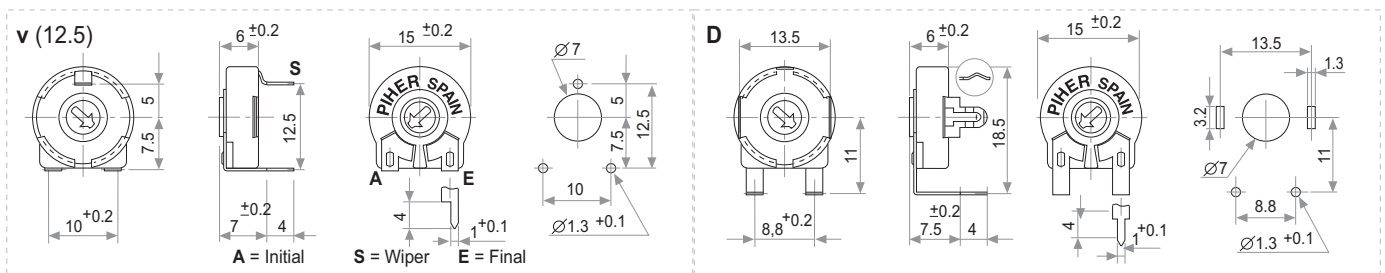

HORIZONTAL MOUNT - VERTICAL ADJUST

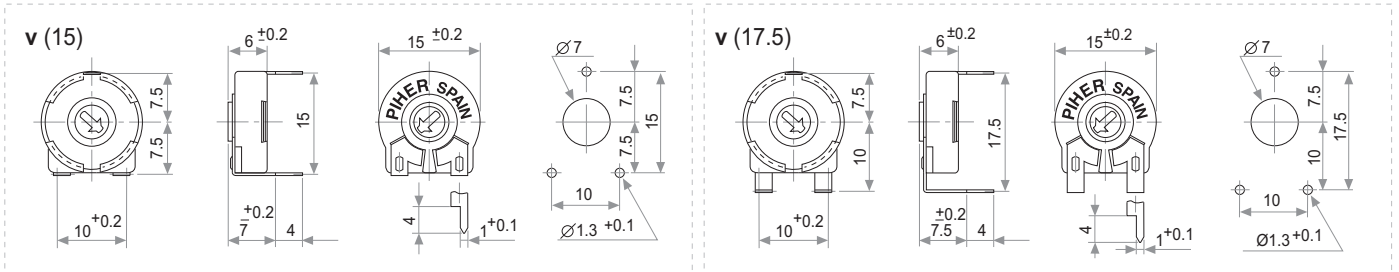
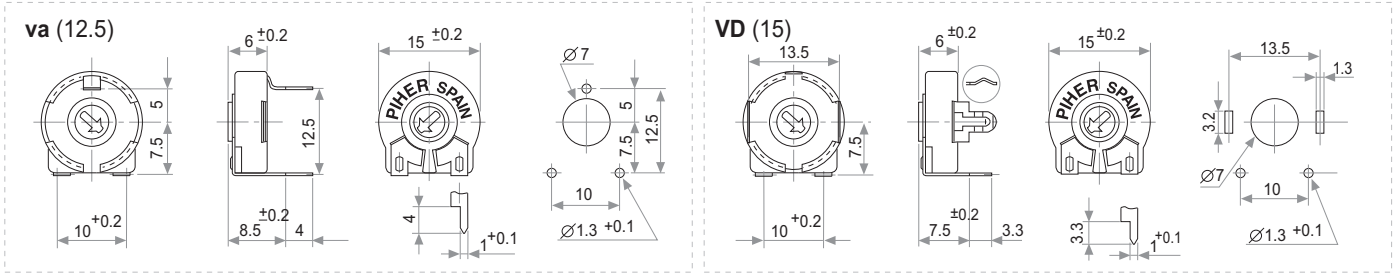

CRIMPED TERMINALS (DETAIL)

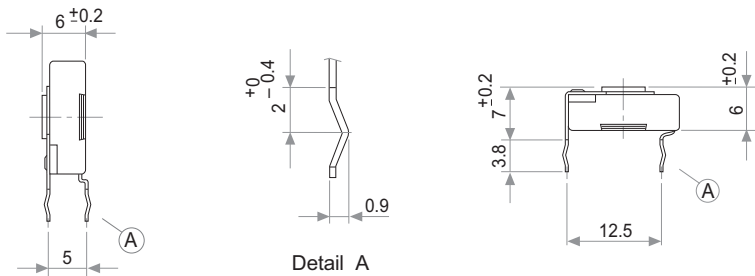

POWER RATING CURVE

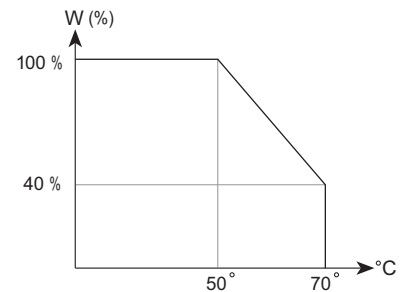

TAPERS

NOTE: Please note terminals disposition when ordering non linear curves.

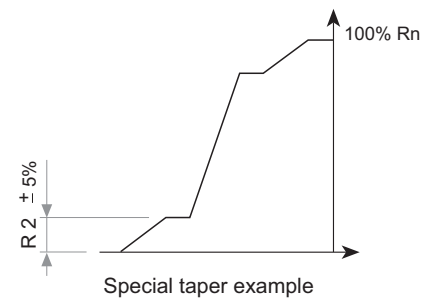
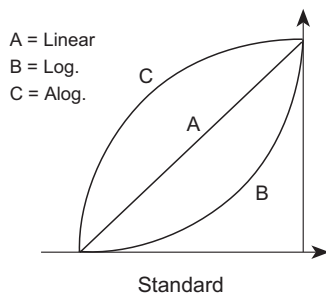

OPTIONS

Positioning

P.M.
50% ±20°



Std. Position = CCW

Cut Track

CCW on-off (A)

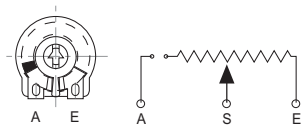

A = Initial
S = Wiper
E = Final

CW on-off (E)

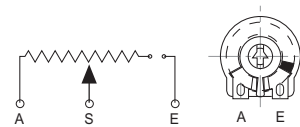

TESTS

TYPICAL VARIATIONS

ELECTRICAL LIFE	1.000 h. @ 50°C; 0.25 W	±5 %
MECHANICAL LIFE (CYCLES)	500 @ 10 CPM ...15 CPM	±3 % (Rn < 1 MΩ)
TEMPERATURE COEFFICIENT	-25°C; +70°C	±300 ppm (Rn <100 K)
THERMAL CYCLING	16 h. @ 85°C; 2h. @ - 25°C	±2.5 %
DAMP HEAT	500 h. @ 40°C @ 95% HR	±5 %
VIBRATION (for each plane X,Y,Z)	2 h. @ 10 Hz. ... 55 Hz.	±2 %

NOTE : Out of range values may not comply these results.

SHAFTS

Hollow model shafts

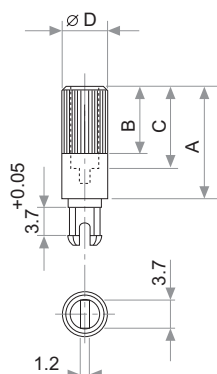

A = Length (FRS)
 B = Knurling length
 C = Hollow depth
 D = Shaft diameter
 FRS = From rotor surface

FIG.	A	B	C	D	Ref.
1	12	9	8	6	5272
2	19	9	15	6	5214
5	9.5	6.5	5.5	6	5208
9	35	9	31	6	5216
10	37.8	9	33.8	6	5218
11	35	25	15	6	5209
13	7.8	4.8	3.8	6	5265

Solid model shafts

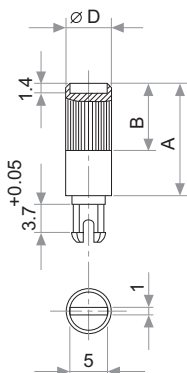
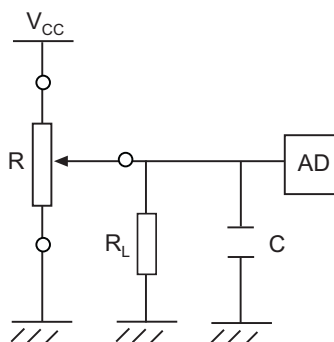

FIG.	A	B	D	Ref.
6	15	9	6	5219
7	16.8	9	6	5220
8	25.3	9	6	5207
12	46	5	6	5227

Slot (1 x 1.4) perpendicular to wiper position. Fig. 12 slot is on line with wiper position.

RECOMMENDED CONNECTIONS

Recommended connection scheme for Piher's position sensors (voltage divider)



$$R_L \approx 100 \times R$$

SHAFTS

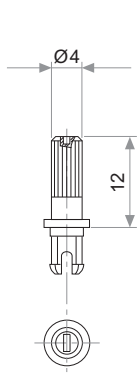

Fig. 3 / Ref. 5372

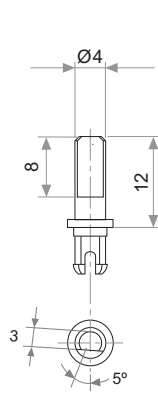

Fig. 15 / Ref. 5217

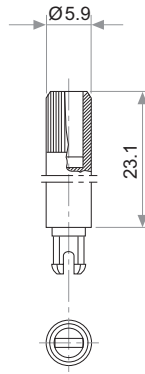

Fig. 17 / Ref. 5210

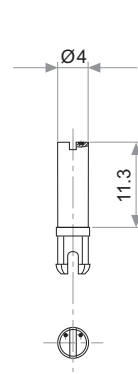

Fig. 18 / Ref. 5271

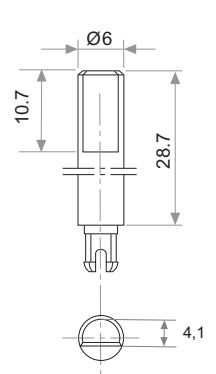

Fig. 19 / Ref. 6032*

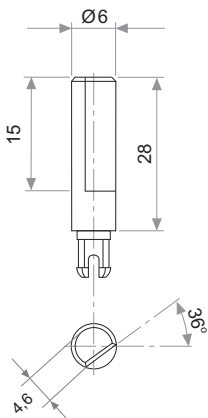

Fig. 20 / Ref. 5369*

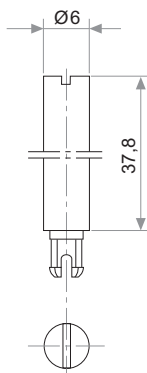

Fig. 21 / Ref. 6031*

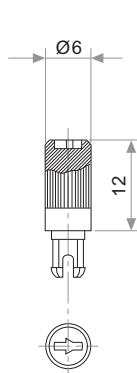

Fig. 22 / Ref. 6029

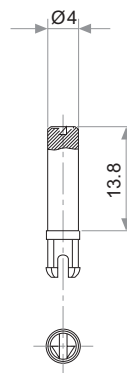

Fig. 23 / Ref. 6022

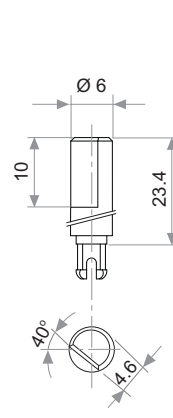

Fig. 29 / Ref. 6162

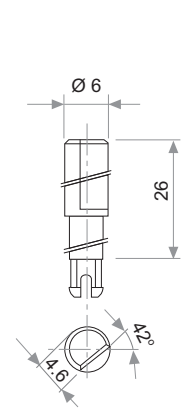

Fig. 25 / Ref. 6059

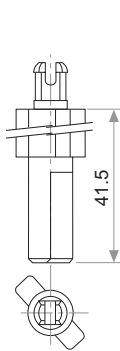

Fig. 27 / Ref. 5268*

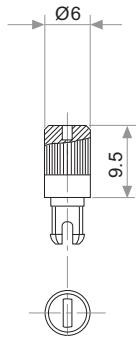

Fig. 28 / Ref. 6055

* Not available in self extinguishable plastic

THUMBWHEEL

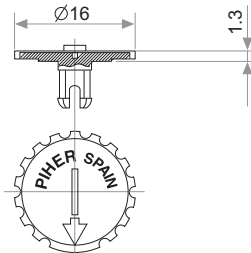

Fig. 4 / Ref. 5371