

# Juego Kraftform Kompakt 400 RA Set 1, 17 piezas

Serie 400 Mango en T



<b>GTIN:</b>	4013288222879	<b>Dimensión:</b>	150x130x50 mm
<b>N° de pieza:</b>	05023471001	<b>Peso:</b>	567 g
<b>N° de artículo:</b>	Kraftform Kompakt 400 RA Set 1	<b>País de origen:</b>	CZ
		<b>Partida arancelaria:</b>	82079030

- La carraca que viene integrada dispone de un dentado fino y permite un trabajo rápido y seguro
- Permite un trabajo muy práctico gracias al mecanismo de carraca que viene integrado plenamente en el mango
- Palanca de conmutación para un cambio de dirección de derecha/izquierda muy cómodo
- Un mango ergonómico bicomponente con encajes para los dedos y una sensación agradable que permite una alta transmisión de las fuerzas y un trabajo libre de molestias y fatiga
- Porta-puntas Rapidaptor con manguito de giro rápido para un cambio ultrarrápido de las puntas y una alta velocidad de trabajo
- Para puntas con arrastre hexagonal exterior de 1/4" según la norma DIN ISO 1173-C 6,3 y E 6,3
- Un manguito de giro rápido para velocidades de trabajo extremadamente altas

Un juego de 17 piezas en un estuche de material textil robusto. 1 porta-puntas manual de mango en "T" 416 RA con función de carraca y sistema de cambio rápido Rapidaptor para puntas de 1/4". La carraca integrada con dentado fino (80 dientes/ángulo de retorno de 4,5°) facilita y acelera el trabajo en uniones atornilladas y evita las molestias de tener que reposicionar el útil constantemente. El mecanismo de carraca que está integrado de forma completa en el mango, permite un trabajo sumamente práctico y agradable. Con una palanca de conmutación para realizar el cambio de giro derecha/izquierda cómodamente con una sola mano. La forma ergonómica del mango rellena toda la palma de la mano, los dedos se encuentran ubicados de manera segura en las cavidades suavemente redondeadas del mango. Así toda la mano entra en contacto con el mango y se evitan las pérdidas por fricción entre mano y mango. Porta-puntas para puntas de arrastre hexagonal exterior de 1/4" según la norma DIN ISO 1173-C 6,3 y E 6,3. Con tecnología Rapidaptor para un cambio ultrarrápido de las puntas. 16 puntas duras y resistentes, de 1/4", de un largo de 89 mm, para el uso universal.

## Enlace web

[https://products.wera.de/es/destornilladores\\_serie\\_400\\_mango\\_en\\_t\\_kraftform\\_kompakt\\_400\\_ra\\_set\\_1.html](https://products.wera.de/es/destornilladores_serie_400_mango_en_t_kraftform_kompakt_400_ra_set_1.html)

Wera - Kraftform Kompakt 400 RA Set 1  
05023471001 - 4013288222879

Wera Werkzeuge GmbH  
Korzter Straße 21-25  
D-42349 Wuppertal  
Tel: +49 (0)2 02 / 40 45-0  
E-Mail: info@wera.de

### Función de carraca



La mecánica de carraca del portapuntas manual con mango en "T" 416 RA está completamente integrada en el mango. La forma compacta del útil permite un trabajo manejable y práctico.

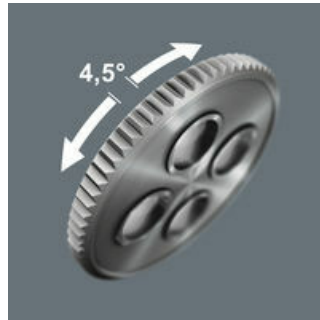

La carraca integrada con su dentado fino de 80 Zähne y un ángulo de retorno de 4,5°, facilita y acelera el trabajo de atornillar evitando la molestia de tener que cambiar el agarre constantemente.

### Mecanismo de carraca integrado en el mango

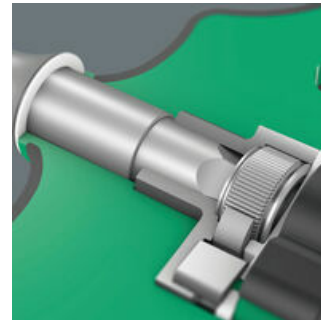

La mecánica de carraca del portapuntas manual con mango en "T" 416 RA está completamente integrada en el mango. La forma compacta del útil permite un trabajo manejable y práctico.

### Conmutación de derecha/izquierda

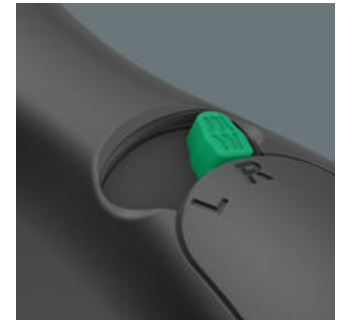

El cambio de dirección se puede realizar muy cómodamente por medio de la palanca de conmutación.

### Manguito de giro rápido

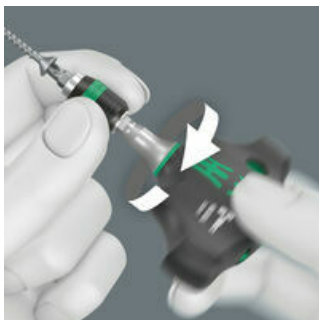

Gracias al manguito de giro rápido, durante el trabajo de atornillar la herramienta se puede guiar de forma segura, y así es posible aumentar la velocidad de trabajo.

### Mango en "T" bicomponente ergonómico



El mango en "T" bicomponente de forma ergonómica dispone de encajes para el apoyo de los dedos y una superficie agradable al tacto lo que permite una alta transmisión de la fuerza y un trabajo sin molestias y fatiga.

### "Rapid-in" y autobloqueo



Sin accionar el casquillo se puede encajar la punta en el portapuntas. En el momento en el que la punta se coloca en el tornillo, automáticamente se activa el bloqueo. Ahora la punta queda alojada de forma segura y sin tambaleo.

### "Rapid-out"

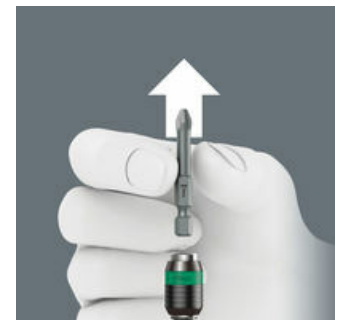

Para cambiar la punta simplemente se ha de desplazar el casquillo hacia adelante: En ese instante, el mecanismo de muelle separa la punta del imán y desbloquea así la herramienta. La punta se puede extraer sin problema alguno. Y lo que es especialmente útil: esta función también permite la extracción de puntas de dimensiones muy pequeñas sin que se tenga que utilizar herramienta adicional de ayuda.

### Enlace web

[https://products.wera.de/es/destornilladores\\_serie\\_400\\_mango\\_en\\_t\\_kraftform\\_kompakt\\_400\\_ra\\_set\\_1.html](https://products.wera.de/es/destornilladores_serie_400_mango_en_t_kraftform_kompakt_400_ra_set_1.html)

Wera - Kraftform Kompakt 400 RA Set 1  
05023471001 - 4013288222879

Wera Werkzeuge GmbH  
Korzter Straße 21-25  
D-42349 Wuppertal  
Tel: +49 (0)2 02 / 40 45-0  
E-Mail: info@wera.de

Contenido del juego:

**416 RA Destornillador de puntas de mango en "T" con función de carraca y sistema de cambio rápido Rapidaptor, 1/4 x 45 mm**

 05023461001 1x 1/4 x 45 mm



**851/4 Z Puntas Phillips, PH 2 x 89 mm**

 05059775001 1x PH 2 x 89 mm  
05059795001 1x PH 3 x 89 mm



**855/4 Z Puntas Pozidriv, PZ 2 x 89 mm**

 05060035001 1x PZ 2 x 89 mm  
05060043001 1x PZ 3 x 89 mm



**867/4 Z Puntas TORX®, TX 10 x 89 mm**

 05060186001 1x TX 10 x 89 mm  
05060187001 1x TX 15 x 89 mm  
05060188001 1x TX 20 x 89 mm  
05060189001 1x TX 25 x 89 mm  
05060191001 1x TX 30 x 89 mm  
05060192001 1x TX 40 x 89 mm



**840/4 Z Puntas hexagonales, 3 x 89 mm**

 05059630001 1x 3 x 89 mm  
05059631001 1x 4 x 89 mm  
05059632001 1x 5 x 89 mm  
05059633001 1x 6 x 89 mm  
05059637001 1x 8 x 89 mm



**800/4 Z Puntas Planas, 1 x 5.5 x 89 mm**

 05059488001 1x 1 x 5.5 x 89 mm



**Cinta autoadhesiva 120, 50 x 120 mm**

1x 50 x 120 mm



Enlace web

[https://products.wera.de/es/destornilladores\\_serie\\_400\\_mango\\_en\\_t\\_kraftform\\_kompakt\\_400\\_ra\\_set\\_1.html](https://products.wera.de/es/destornilladores_serie_400_mango_en_t_kraftform_kompakt_400_ra_set_1.html)

Wera - Kraftform Kompakt 400 RA Set 1  
05023471001 - 4013288222879

Wera Werkzeuge GmbH  
Korzter Straße 21-25  
D-42349 Wuppertal  
Tel: +49 (0)2 02 / 40 45-0  
E-Mail: info@wera.de

# Kraftform Kompakt 400 RA Set 1, 17 pieces

Series 400 T-Handle



<b>EAN:</b>	4013288222879	<b>Size:</b>	150x130x50 mm
<b>Part number:</b>	05023471001	<b>Weight:</b>	567 g
<b>Article number:</b>	Kraftform Kompakt 400 RA Set 1	<b>Country of origin:</b>	CZ
		<b>Customs tariff number:</b>	82079030

- The integrated ratchet with fine tooththing ensures fast and safe working
- Convenient working thanks to the ratchet mechanism fully embedded in the handle
- Reversing lever for comfortable clockwise/counterclockwise direction change
- Ergonomic 2-component handle with finger handle recesses and pleasant surface feel for very high power transmission and fatigue-free working
- Rapidaptor bitholding screwdriver with fast-rotating sleeve for lightning-fast bit changes and high working speeds
- For bits with 1/4" external hexagon drive as per DIN ISO 1173-C 6.3 and E 6.3
- Fast-rotating sleeve for extremely high working speed

17-piece set in a robust textile box. One 416 RA T-handle bitholding screwdriver with ratchet function and Rapidaptor quick-release chuck for 1/4" bits. The integrated ratchet with fine tooththing (80 teeth/return angle 4.5°) eases and accelerates screwdriving without having to reposition the tool. The ratchet mechanism completely embedded in the handle ensures very handy and comfortable work. With reversing lever for comfortable clockwise/counterclockwise direction change in one-hand operation. The ergonomic shape of the handle fills the ball of the hand well, the fingers lie securely in the softly rounded recessed grips. The whole hand comes into contact with the handle, friction loss between hand and handle is avoided. Bit holder for bits with 1/4" external hexagon drive as per DIN ISO 1173-C 6.3 and E 6.3. With Rapidaptor technology for lightning-fast bit changes. 16 tough bits, 1/4", 89 mm long, for universal use.

## Web link

[https://products.wera.de/en/screwdrivers\\_series\\_400\\_t-handle\\_kraftform\\_kompakt\\_400\\_ra\\_set\\_1.html](https://products.wera.de/en/screwdrivers_series_400_t-handle_kraftform_kompakt_400_ra_set_1.html)

Wera - Kraftform Kompakt 400 RA Set 1  
05023471001 - 4013288222879

Wera Werkzeuge GmbH  
Korzter Straße 21-25  
D-42349 Wuppertal  
Tel: +49 (0)2 02 / 40 45-0  
E-Mail: info@wera.de

**Ratchet function**



The ratchet mechanism of the 416 RA T-handle bitholding screwdriver is completely embedded in the handle. The compact shape of the tool allows convenient working.

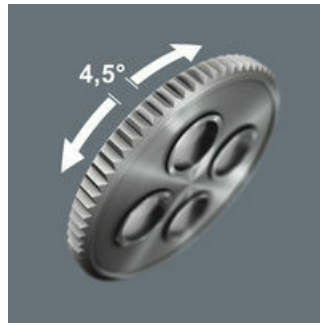

The integrated ratchet with fine toothing (80 teeth) and a return angle of 4.5° eases and accelerates screwdriving without having to reposition the tool.

**Ratchet mechanism in the handle**

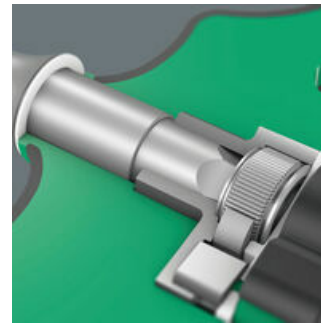

The ratchet mechanism of the 416 RA T-handle bitholding screwdriver is completely embedded in the handle. The compact shape of the tool allows convenient working.

**Reversible clockwise/counterclockwise**

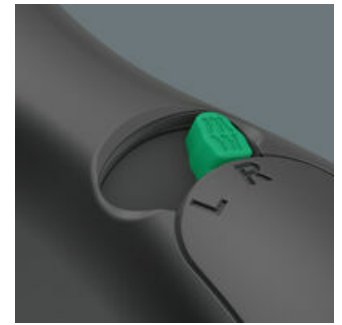

The change of direction can easily be made using the reversing lever.

**Fast-rotating sleeve**

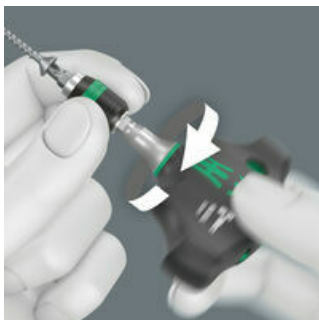

The fast-rotating sleeve allows the tool to be guided safely while screwdriving and increases the working speed.

**Ergonomic 2-component T-handle**



The ergonomically shaped 2-component T-handle with finger recesses and pleasant surface facilitates very high power transmission and fatigue-free working.

**Rapid-in and self-lock**



The bit can be pushed into the adaptor without moving the sleeve. The lock is activated automatically as soon as the bit is applied to the screw. Bits are held securely and wobble-free.

**Rapid-out**



Simply push the sleeve forward to change the bit. The spring mechanism lifts the bit off the magnet and unlocks the tool. The bit can be easily removed. The rapid-out function makes it easy to remove even the smallest bits without extra tools.

**Web link**

[https://products.wera.de/en/screwdrivers\\_series\\_400\\_t-handle\\_kraftform\\_kompakt\\_400\\_ra\\_set\\_1.html](https://products.wera.de/en/screwdrivers_series_400_t-handle_kraftform_kompakt_400_ra_set_1.html)

Wera - Kraftform Kompakt 400 RA Set 1  
05023471001 - 4013288222879

Wera Werkzeuge GmbH  
Korzter Straße 21-25  
D-42349 Wuppertal  
Tel: +49 (0)2 02 / 40 45-0  
E-Mail: [info@wera.de](mailto:info@wera.de)

# Kraftform Kompakt 400 RA Set 1, 17 pieces

## Series 400 T-Handle





### Set contents:

#### 416 RA T-handle bitholding screwdriver with ratchet function and Rapidaptor quick-release chuck, 1/4 x 45 mm

 05023461001 1x 1/4 x 45 mm





#### 851/4 Z bits, PH 2 x 89 mm

 05059775001 1x PH 2 x 89 mm  
 05059795001 1x PH 3 x 89 mm









#### 855/4 Z bits, PZ 2 x 89 mm

 05060035001 1x PZ 2 x 89 mm  
 05060043001 1x PZ 3 x 89 mm







#### 867/4 Z TORX® bits, TX 10 x 89 mm

 05060186001 1x TX 10 x 89 mm  
 05060187001 1x TX 15 x 89 mm  
 05060188001 1x TX 20 x 89 mm  
 05060189001 1x TX 25 x 89 mm  
 05060191001 1x TX 30 x 89 mm  
 05060192001 1x TX 40 x 89 mm



#### 840/4 Z bits, 3 x 89 mm

 05059630001 1x 3 x 89 mm  
 05059631001 1x 4 x 89 mm  
 05059632001 1x 5 x 89 mm  
 05059633001 1x 6 x 89 mm  
 05059637001 1x 8 x 89 mm



#### 800/4 Z bits, 1 x 5.5 x 89 mm

 05059488001 1x 1 x 5.5 x 89 mm



#### Hook and Loop Fastener Strip 120, 120 x 50 mm

1x 120 x 50 mm

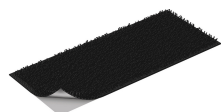

#### Web link

[https://products.wera.de/en/screwdrivers\\_series\\_400\\_t-handle\\_kraftform\\_kompakt\\_400\\_ra\\_set\\_1.html](https://products.wera.de/en/screwdrivers_series_400_t-handle_kraftform_kompakt_400_ra_set_1.html)

Wera - Kraftform Kompakt 400 RA Set 1  
05023471001 - 4013288222879

Wera Werkzeuge GmbH  
Korzter Straße 21-25  
D-42349 Wuppertal  
Tel: +49 (0)2 02 / 40 45-0  
E-Mail: [info@wera.de](mailto:info@wera.de)



<b>EAN:</b>	4013288222879	<b>Dimension:</b>	150x130x50 mm
<b>Numéro de pièce:</b>	05023471001	<b>Poids:</b>	567 g
<b>Numéro d'article:</b>	Kraftform Kompakt 400 RA Set 1	<b>Pays d'origine:</b>	CZ
		<b>Numéro de tarif douanier:</b>	82079030

- Le cliquet à fine denture permet de travailler rapidement et en toute sécurité
- Maniabilité grâce au mécanisme de cliquet entièrement intégré dans le manche
- Levier d'inversion pour changer facilement de sens droite/gauche
- Manche bicomposant ergonomique avec des encoches pour les doigts et une surface agréable permettant de transmettre une force très élevée et de travailler sans fatigue
- Porte-embouts Rapidaptor avec bague de rotation rapide pour le changement éclair des embouts et une vitesse de travail élevée
- Pour embouts à emmanchement hexagonal 1/4" selon DIN ISO 1173-C 6,3 et E 6,3
- Bague de rotation rapide pour une très grande vitesse de travail

Jeu de 17 pièces dans une housse textile robuste. 1 manche en T 416 RA avec fonction cliquet et mandrin à serrage rapide Rapidaptor pour embouts 1/4". Le cliquet intégré à fine denture (80 dents/angle de reprise de 4,5°) simplifie et accélère le vissage. Plus besoin de désengager et repositionner l'outil. Le mécanisme de cliquet entièrement intégré dans le manche rend l'outil très pratique et le travail agréable. Avec levier d'inversion pour changer facilement de sens droite/gauche en un seul geste. La forme ergonomique du manche épouse bien la forme de la paume. Les doigts sont calés dans les arrondis. La main entière est en contact avec le manche, les déperditions par friction entre la main et le manche sont évitées. Porte-embouts pour embouts à emmanchement hexagonal 1/4" selon DIN ISO 1173-C 6,3 et E 6,3. Avec technologie Rapidaptor pour un changement ultrarapide des embouts. 16 embouts extra-rigides, 1/4", 89 mm de long, à usage universel.

### Lien

[https://products.wera.de/fr/tournevis\\_serie\\_400\\_manche\\_en\\_t\\_kraftform\\_kompakt\\_400\\_ra\\_set\\_1.html](https://products.wera.de/fr/tournevis_serie_400_manche_en_t_kraftform_kompakt_400_ra_set_1.html)

Wera - Kraftform Kompakt 400 RA Set 1  
05023471001 - 4013288222879

Wera Werkzeuge GmbH  
Korzter Straße 21-25  
D-42349 Wuppertal  
Tel: +49 (0)2 02 / 40 45-0  
E-Mail: info@wera.de

### Fonction cliquet



Le mécanisme de cliquet du manche en T 416 RA est entièrement intégré dans le manche. La forme compacte de l'outil offre une grande maniabilité.

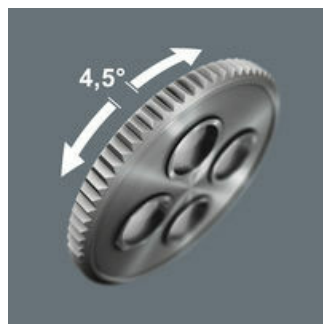

Le cliquet intégré à fine denture (80 dents) avec un angle de reprise de 4,5° simplifie et accélère le vissage. Plus besoin de désengager et repositionner l'outil.

### Mécanisme de cliquet dans le manche

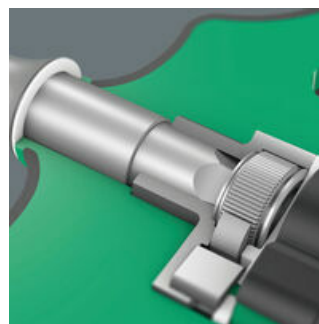

Le mécanisme de cliquet du manche en T 416 RA est entièrement intégré dans le manche. La forme compacte de l'outil offre une grande maniabilité.

### Inversion droite/gauche

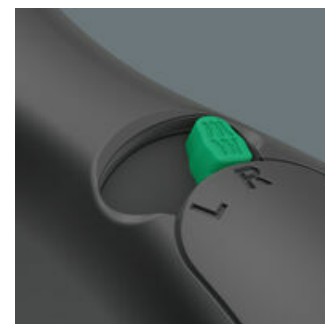

Le levier d'inversion permet de changer de sens facilement.

### Bague de rotation rapide

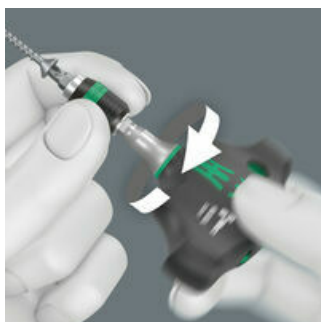

La bague de rotation rapide permet de guider l'outil en toute sécurité pendant le vissage et d'augmenter la vitesse de travail.

### Manche en T ergonomique bicomposant



Avec ses encoches et sa surface agréable, le manche en T ergonomique bicomposant permet de transmettre une force très élevée et de travailler sans fatigue.

### Rapid-in et self-lock

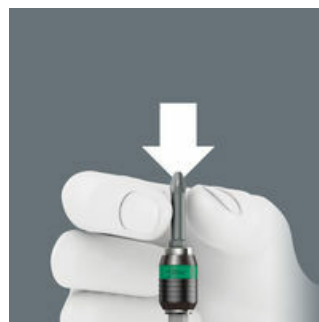

L'embout s'insère dans le logement sans actionner la douille. L'embout se verrouille automatiquement au contact de la vis ; il est positionné fermement en toute sécurité.

### Rapid-out

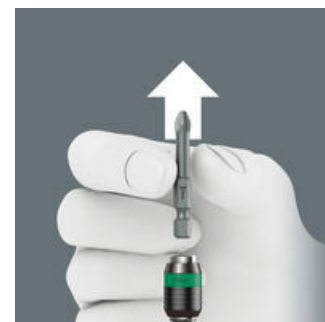

Pour échanger l'embout, il suffit de faire coulisser la douille vers l'avant : le mécanisme à ressort décolle l'embout de l'aimant et déverrouille l'outil. L'embout peut être retiré sans problèmes. Particulièrement utile: retrait des embouts même de tout petit calibre sans aucun outil auxiliaire.

### Lien

[https://products.wera.de/fr/tournevis\\_serie\\_400\\_manche\\_en\\_t\\_kraftform\\_kompakt\\_400\\_ra\\_set\\_1.html](https://products.wera.de/fr/tournevis_serie_400_manche_en_t_kraftform_kompakt_400_ra_set_1.html)

Wera - Kraftform Kompakt 400 RA Set 1  
05023471001 - 4013288222879

Wera Werkzeuge GmbH  
Korzter Straße 21-25  
D-42349 Wuppertal  
Tel: +49 (0)2 02 / 40 45-0  
E-Mail: [info@wera.de](mailto:info@wera.de)



Série 400 – manche en T



Contenu du jeu:

**416 RA Manche en T avec fonction cliquet et mandrin à serrage rapide Rapidaptor, 1/4 x 45 mm**

 05023461001 1x 1/4 x 45 mm





**851/4 Embouts Z, PH 2 x 89 mm**

 05059775001 1x PH 2 x 89 mm  
 05059795001 1x PH 3 x 89 mm



**855/4 Embouts Z, PZ 2 x 89 mm**

 05060035001 1x PZ 2 x 89 mm  
 05060043001 1x PZ 3 x 89 mm



**867/4 Z Embouts TORX®, TX 10 x 89 mm**

 05060186001 1x TX 10 x 89 mm  
 05060187001 1x TX 15 x 89 mm  
 05060188001 1x TX 20 x 89 mm  
 05060189001 1x TX 25 x 89 mm  
 05060191001 1x TX 30 x 89 mm  
 05060192001 1x TX 40 x 89 mm



**840/4 Embouts Hex-Plus Z, 3 x 89 mm**

 05059630001 1x 3 x 89 mm  
 05059631001 1x 4 x 89 mm  
 05059632001 1x 5 x 89 mm  
 05059633001 1x 6 x 89 mm  
 05059637001 1x 8 x 89 mm



**800/4 Embouts Z, 1 x 5.5 x 89 mm**

 05059488001 1x 1 x 5.5 x 89 mm



**Bande autocollante 120, 50 x 120 mm**

1x 50 x 120 mm

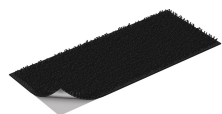

Lien

[https://products.wera.de/fr/tournevis\\_serie\\_400\\_manche\\_en\\_t\\_kraftform\\_kompakt\\_400\\_ra\\_set\\_1.html](https://products.wera.de/fr/tournevis_serie_400_manche_en_t_kraftform_kompakt_400_ra_set_1.html)

Wera - Kraftform Kompakt 400 RA Set 1  
 05023471001 - 4013288222879

Wera Werkzeuge GmbH  
 Korzter Straße 21-25  
 D-42349 Wuppertal  
 Tel: +49 (0)2 02 / 40 45-0  
 E-Mail: info@wera.de