

Drawing(mm)

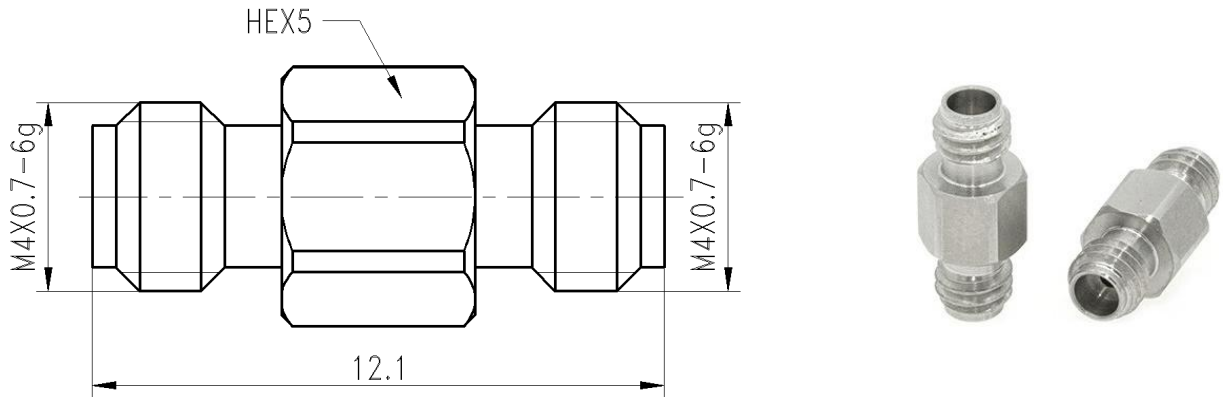

Electrical & Environmental

Impedance	50 ohm
Frequency Range	110 GHz
VSWR	1.35 max
Operating Temp	-55°C to +85°C
Interface	1.0mm per IEC 61169

Material

Connector Body	Passivated stainless steel
Center Contact	Gold plated beryllium copper
Insulator	PEI

Typical Test Data

