

Digital Oscilloscopes

XDO2025

2-channel - 25 MHz

XDO2040

2-channel - 40 MHz

User's manual

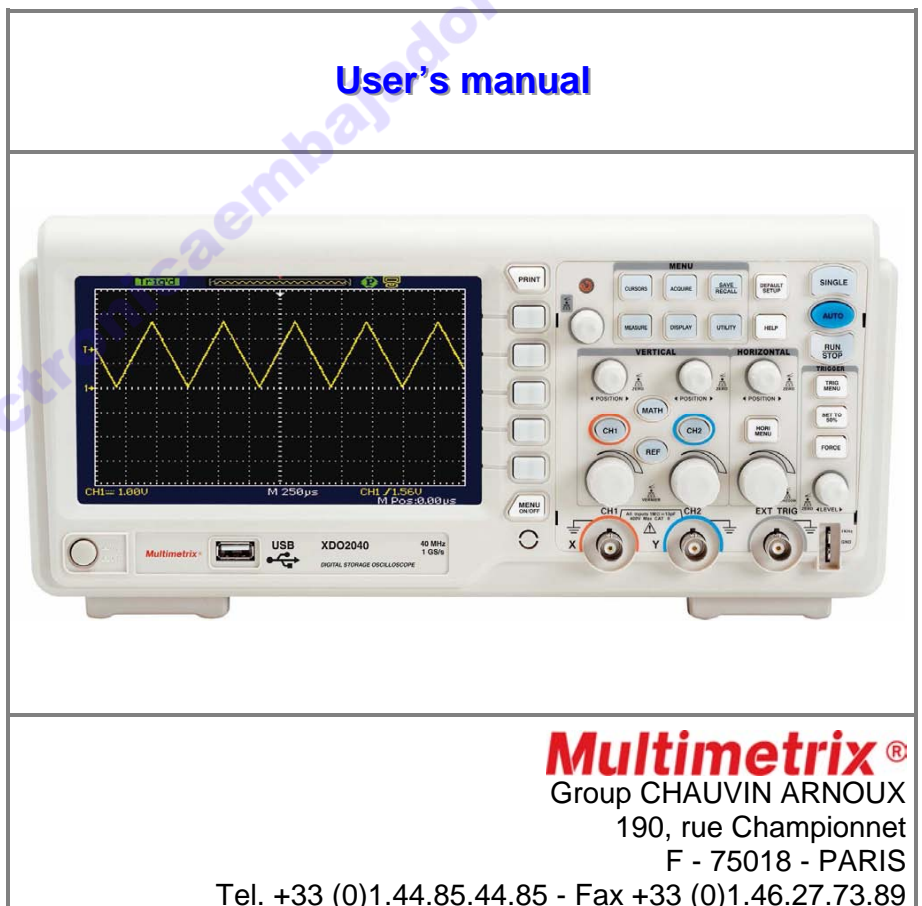

Multimetrix®

Group CHAUVIN ARNOUX

190, rue Championnet

F - 75018 - PARIS

Tel. +33 (0)1.44.85.44.85 - Fax +33 (0)1.46.27.73.89

Content

General Instructions

Introduction.....	4
Precautions and safety measures	4
Symbols on instrument.....	5
Guarantee, Repair, Servicing	5

Instrument Description

Front panel	6
<i>XDO2025 - XDO2040.....</i>	<i>6</i>
Rear panel	10
<i>XDO2025 - XDO2040.....</i>	<i>10</i>

Functional Description

AUTO Setup	11
Auto Setup, screen, symbol	11
<i>Autoset function menu.....</i>	<i>12</i>
VERTICAL System	13
CH1 - CH2 Channel.....	13
<i>CH1 & CH2 function menus</i>	<i>14</i>
Knobs in the Vertical mode	15
Vertical "POSITION" knob.....	15
Volts/div knob.....	15
MATH functions	16
MATH function menu.....	16
MATH function instruction.....	16
FFT Spectrum Analyser	17
FFT function menus.....	17
Select FFT window.....	17
Measuring an FFT Spectrum using cursors.....	18
Measuring an FFT amplitude.....	18
Measuring FFT frequency.....	19
Using REF	20
REF function menu.....	20
HORIZONTAL System	21
Horizontal System	21
Horizontal system function menu.....	21
Knobs in Horizontal mode.....	22
Horizontal "POSITION" knob.....	22
Volts/div knob.....	22
Display scan mode.....	22
Delayed.....	22
TRIGGER System	23
Trigger System	23
Signal Source.....	23
Edge Trigger	23
Edge Trigger function menu.....	23
Trigger Setup function menu.....	24
Pulse Trigger.....	25
Pulse Trigger function menus.....	25
Video Trigger	27
Video Trigger function menus.....	27
Slope Trigger	29
Slope Trigger function menus.....	29

Content (cont'd)

Alternative Trigger	31
Edge Trigger function menu.....	31
Pulse Trigger function menus.....	32
Video Trigger function menus.....	33
Slope Trigger function menus	34
Trigger Holdoff.....	36
ACQUISITION System	37
Acquiring Signal System	37
Acquiring signal function menu.....	37
DISPLAY System	38
Display System	38
Display system function menus.....	38
X-Y Format	41
MEASURE System	42
Scale Measurement	42
Cursor Measurement.....	42
Manual cursor function menu.....	42
Track mode function menu.....	43
Auto mode function menu.....	44
Auto Measurement	45
Auto measure function menu.....	45
Auto mode function menu : Voltage measure.....	45
Auto mode function menu : Time measure.....	46
Auto mode function menu : Delay measure.....	46
All measurement function menu.....	47
Introduction of the measure type.....	47
STORAGE System	49
Storage System.....	49
Save / Recall Interface.....	49
Save / Recall.....	50
Save / Recall setups to device.....	50
Save / Recall setups to USB flash drive.....	51
Recall factory setup.....	53
Save / Recall waveform.....	53
Save / Recall waveform to device.....	53
Save / Recall waveform to USB flash drive.....	54
Save picture	56
Save / Recall Reference Waveform.....	57
UTILITY System	58
Utility System	58
System status	62
Print.....	62
Update Firmware	64
Pass/Fail	65
Mask Setting	67
Waveform Record.....	69
Playback	70
Recorder.....	71
Technical Specifications.....	74
General Specifications	77

General Instructions

Introduction

You have just acquired a **2-channel digital oscilloscope** :

- XDO2025, 25 MHz or
- XDO2040, 40 MHz.

This 2-channel oscilloscope provides a set of powerful features for a wide range of applications such as production, education, maintenance, service, research and development.

Congratulations for your choice and thank you for your trust in the quality of our products.

This instrument conforms to safety standard NF EN 61010-1 (2001), single insulation, and relative to electronic measurement instruments.

To obtain optimum service, read these instructions with care and comply with the precautions for use.

Failure to comply with these warnings and/or user instructions is liable to cause damage to the equipment and/or its components. This could be dangerous to the user.

Precautions and safety measures

- This instrument has been designed for use:
 - indoors,
 - in a pollution degree 2 environment,
 - at an altitude of less than 2000 m,
 - at a temperature included between 10°C and 40°C
 - with relative humidity up to 95 %.
- It can be supplied by a 240 V CAT II network.

definition of installation categories (cf. CEI 664-1)

CAT I : CAT I circuits are protected by devices designed to minimize transient overvoltages at a low level.

E.g.: protected electronic circuits

CAT II :CAT II circuits are domestic or similar equipment power supply circuits that can include average value transient overvoltages.

E.g.: power supply to domestic appliances and portable tools.

CAT III : CAT III circuits are circuits for power equipment power supplies which may include high transient overvoltages.

E.g.: machine or industrial apparatus power supply.

CAT IV : CAT IV circuits are circuits that can include very high transient overvoltages.

E.g.: energy inputs

before use

- Comply with environment and storage conditions.

during use

- Read carefully all the notes preceded by the symbol .
- Connect the instrument to an outlet with a ground pin.
- Be sure not to obstruct the aeration points.
- As a safety measure, use only suitable cords and accessories supplied with the instrument or type approved by the manufacturer.
- When the instrument is connected to the measurement circuits, never touch an unused terminal.

General Instructions (cont'd)

Symbols on instrument



Warning: Risk of danger.
Refer to the operating manual to find out the nature of the potential hazards and the action necessary to avoid such hazards.



Selective sorting of waste for recycling electric and electronic materials.
In accordance with the WEEE 2002/96/EC directive: must not be treated as household waste.



Earth symbol



USB symbol

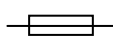

Fuse symbol



European Conformity

Guarantee

This equipment is guaranteed for 1 year against any material defect or manufacturing faults, in conformity with the general conditions of sale.

During this period, the manufacturer may only repair the equipment. He reserves the right to carry out repair or replacement of all or part of the equipment.

If the equipment is returned to the manufacturer, forward transport is at the expense of the customer.

The guarantee does not apply in the event of:

- unsuitable use of the equipment or by association with incompatible equipment
- modification of the equipment without the explicit authorization of the manufacturer technical services
- operation by a person not approved by the manufacturer
- adaptation to a specific application not provided for in the equipment definition or in the operating instructions impact
- fall or flooding.

Repair

Return your instrument to your distributor for any work to be done within or outside the guarantee.

Servicing

- Turn the instrument off.
- Clean it with a damp cloth and soap.
- Never use abrasive products or solvents.
- Allow drying before any further use.

Instrument Description

Front panel

XDO2025

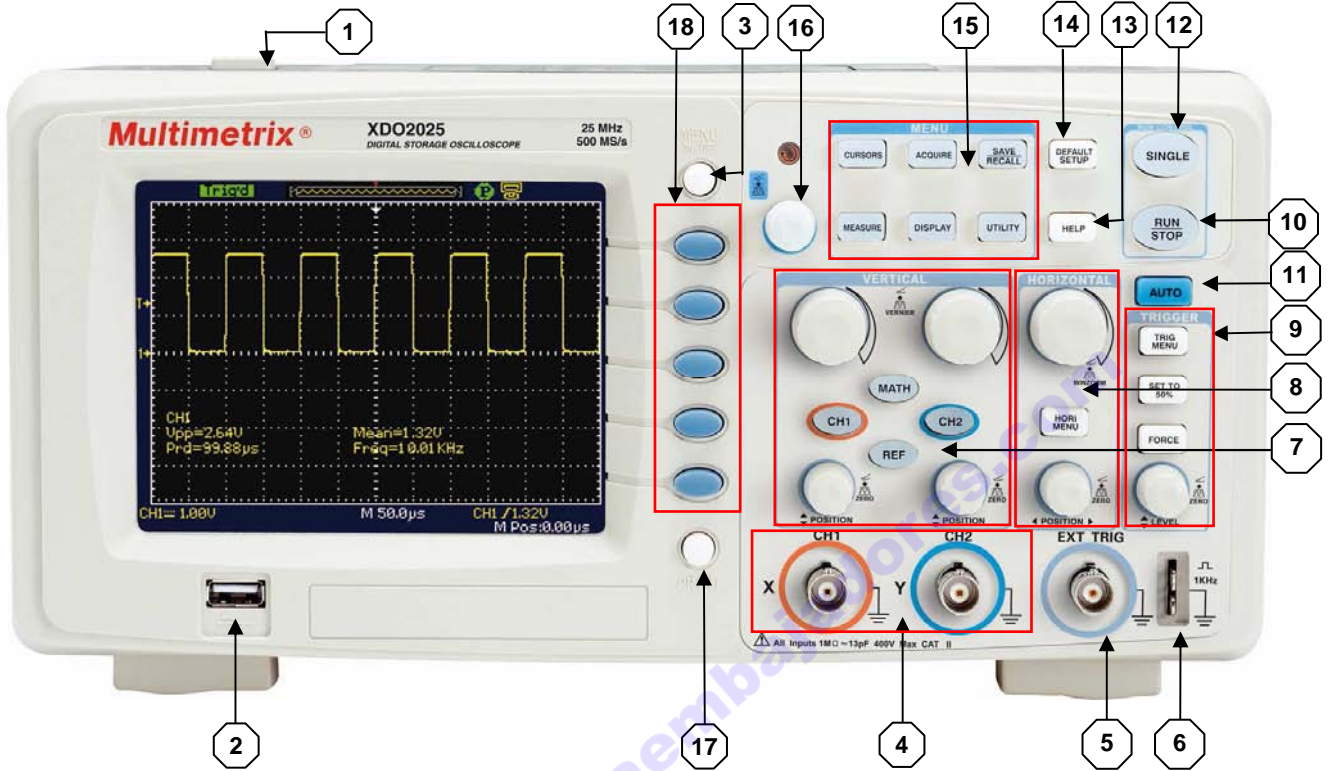

XDO2040

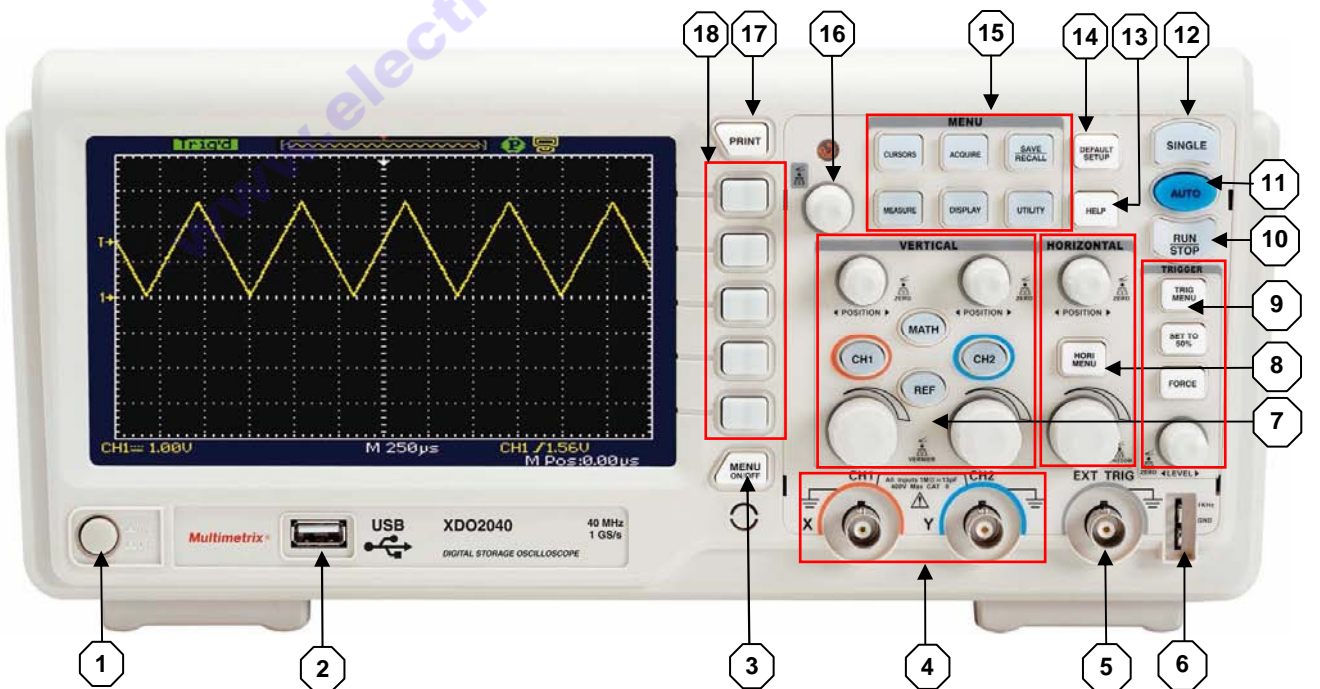

Instrument Description (cont'd)

Front panel (cont'd)

1 - POWER	Power ON / Power OFF
2 - USB	USB HOST interface connection
3 - MENU	MENU ON / OFF
4 - CH1 - CH2	Input connectors for waveform display
5 - EXT TRIG	Input connector for an external trigger source. Use the Trigger Menu to select the "Ext" or "Ext/5" trigger source.
6 - PROBE	Voltage probe compensation output and ground. Use to electrically match the probe to the oscilloscope input circuit.
7 - VERTICAL	Vertical system key pad (see p. 7 and 12).
8 - HORIZONTAL	Horizontal system key pad (see p. 7 and 20).
9 - TRIGGER	Trigger system key pad (see p. 8 and 22).
10 - RUN / STOP	Continuously acquires waveforms or stops the acquisition.
11 - AUTO	Automatically sets the oscilloscope controls to produce a usable display of the input signals.
12 - SINGLE	Acquires a single waveform and then stops.
13 - HELP	Enters the online help system.
14 - DEFAULT SETUP	Recalls the factory setup (language, saved files, contrast, calibration data).
15 - MENU	Menu key pad (see p. 8).
16 - UNIVERSAL KNOB	Adjusts holdoff, frequency upper and lower limit (and that of the digital filter), x mask and y mask in pass / fail function, record or play back frame in waveform record menu, storage position of setups, waveforms, pictures. This moves cursors, sets pulse width and video lineage, selects menu option.
17 - PRINT	Print menu (see p. 61).
18 - Keys (x 5)	Menu scroll keys

Instrument Description (cont'd)

VERTICAL System

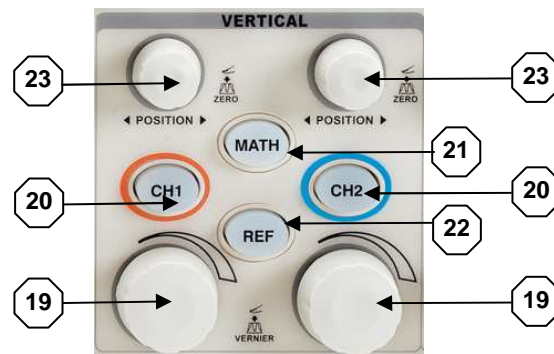

19 - POSITION Volt/div. knobs (see p. 14).

20 - CH1 - CH2 keys Channel 1, Channel 2 menu control button

21 - MATH MATH function control button

22 - REF Reference waveforms control button, saves waveforms to a non volatile memory.

23 - CH1 - CH2 knobs Vertical position knobs (see p. 14).

HORIZONTAL System

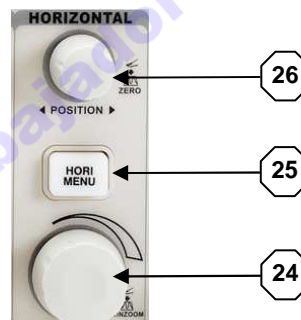

24 - POSITION S/div knob (see p. 21).

25 - HORI MENU Displays the horizontal menu.

26 - HORI knob Horizontal position knob (see p. 21).

TRIGGER System

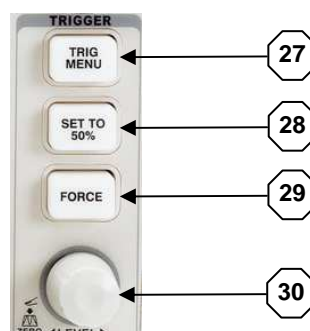

27 - TRIG MENU Activates the Trigger menu.

28 - SET TO 50% Stabilizes a waveform quickly.

29 - FORCE Use the FORCE button to complete the current waveform acquisition whether the oscilloscope detects a trigger or not. This is useful for Single acquisitions and Normal trigger mode.

30 - LEVEL knob Sets the corresponding signal voltage of trigger point, press the knob to set the trigger level to zero.

Instrument Description (cont'd)

MENU key pad

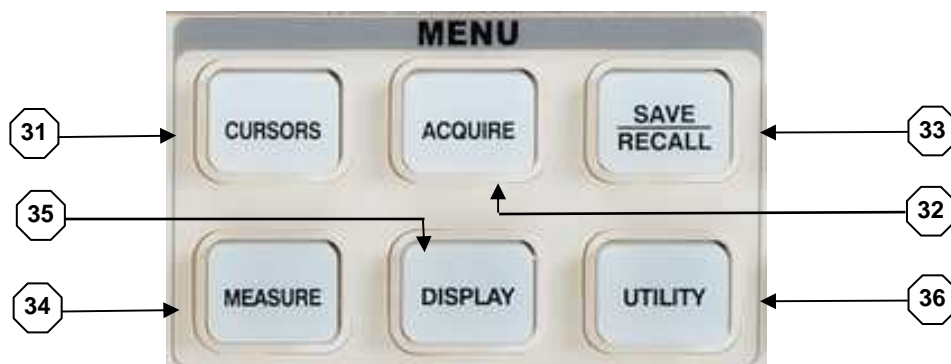

31 - CURSORS

Displays the cursor menu (see p. 41). Vertical Position controls adjust cursor position while displaying the Cursor Menu and the cursors are activated. Cursors remain displayed (unless the "Type" option is set to "Off") after leaving the Cursor menu but are not adjustable.

32 - ACQUIRE

Displays the Acquiring signal system (see p. 35).

33 - SAVE/RECALL

Displays the Save/Recall Menu for setups and waveforms (see p. 48).

34 - MEASURE

Displays the Automatic Measurement menu (see p. 41).

35 - DISPLAY

Displays the Display menu (see p. 37).

36 - UTILITY

Displays the Utility system (see p. 57).

Instrument Description (cont'd)

Rear panel

XDO2025

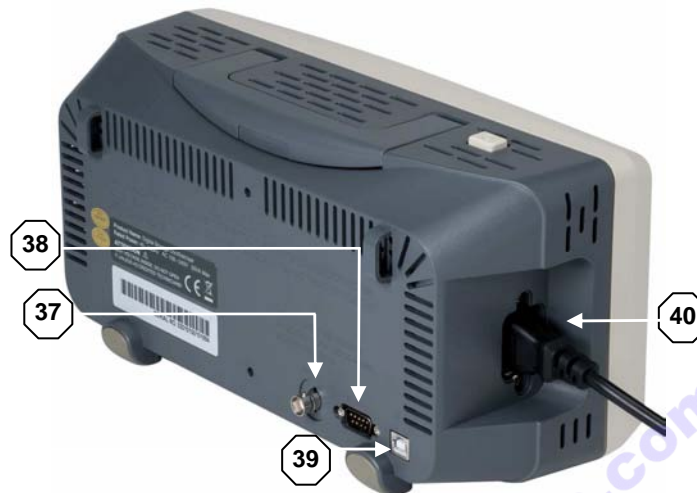

37 - Pass / Fail	PASS / FAIL output
38 - RS 232	RS 232 connector
39 - USB	Back USB connector
40 - Plug	Power input connector

XDO2040



41 - Pass / Fail	PASS / FAIL output
42 - RS 232	RS 232 connector
43 - USB	Back USB connector
44 - Plug	Power input connector

Functional Description

AUTO Setup





Auto Setup

Autoset determines the trigger source based on the following conditions:

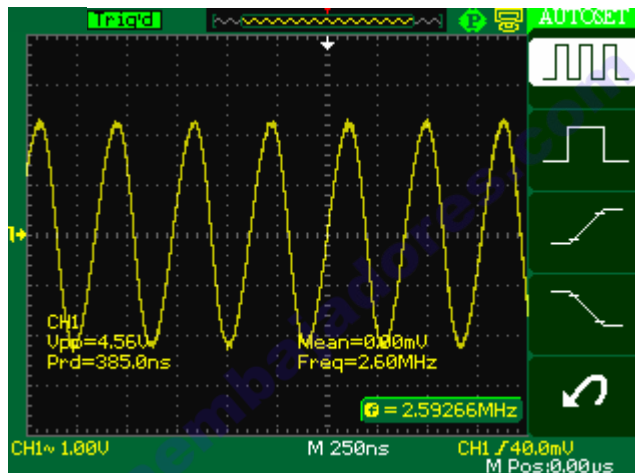
- If multiple channels have signals: channel with the lowest frequency signal.
- No signals found: the lowest-numbered channel displayed when Autoset was invoked.
- No signals found and no channels displayed: the oscilloscope will display and use channel 1.

Input a signal to Channel 1, press the “Auto” button.



 Multi-cycle sine	Auto set the screen and display several cyc signal.
 Single-cycle sine	Set the screen and auto display single cyc signal.
 Rising edge	Auto set and show the rising time.
 Falling edge	Auto set and show the falling time.
 Undo Setup	Causes the oscilloscope to recall the previous setup.

Functional Description

AUTO Setup (cont'd)

Autoset function menu

Function	Setting
Acquire Mode	Adjusted to Sampling
Display Format	Y-T
Display Type	Set to Dots for a video signal, set to Vectors for an FFT spectrum; otherwise, unchanged
Vertical Coupling	Adjusted to DC or AC according to the input signal
Bandwidth Limit	Off (full)
V/div	Adjusted
VOLTS/DIV adjustability	Coarse
Signal inverted	Off
Horizontal position	Centre
S/div	Adjusted
Trigger type	Edge
Trigger source	Auto detect the channel which has the input signal
Trigger slope	Rising
Trigger mode	Auto
Trigger coupling	DC
Trigger holdoff	Minimum
Trigger level	Set to 50%

Functional Description

VERTICAL System

CH1 - CH2 Channel

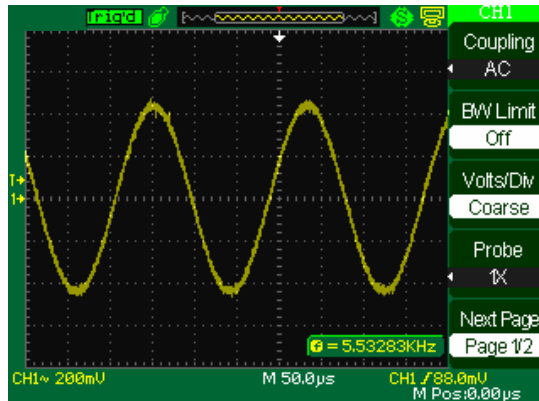

CH1 & CH2
function menu 1

Option	Setting	Description
Coupling	DC	DC passes both AC and DC components of the input signal.
	AC	AC blocks the DC component of the input signal and attenuates signals below 10 Hz.
	GND	GND disconnects the input signal.
BW limit (XDO2040 only)	On Off	Limits the bandwidth to reduce display noise; filters the signal to reduce noise and other unwanted high frequency components.
Volts/Div	Coarse Fine	Selects the resolution of the Volts/Div knob Coarse defines a 1-2-5 sequence. Fine changes the resolution to small steps between the coarse settings (higher than 20 MHz are obstructed).
Probe	1 x 5 x 10 x 100 x 500 x 1000 x	Set to match the type of probe you are using to ensure correct vertical readouts.

Functional Description

VERTICAL System (cont'd)

CH1 & CH2 function menu 2

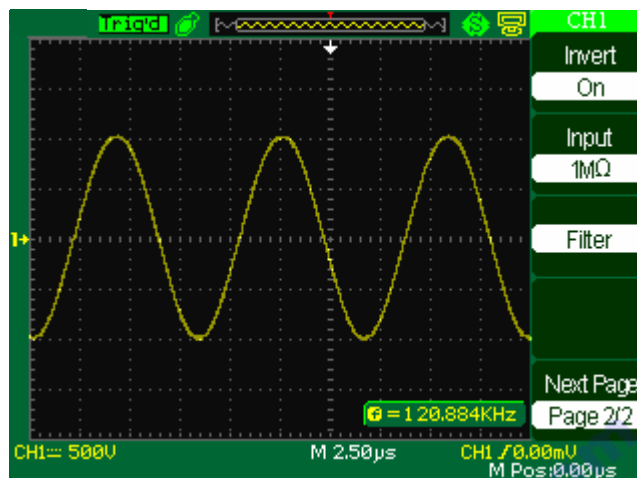

Option	Setting	Description
Invert	on off	Turn on invert function. Turn off invert function. Turn the “Universal knob” to adjust them.
Digital Filter		Press this button to enter the “Digital Filter menu”.

Digital filter function menu

Option	Setting	Description
Digital Filter	on off	Turn on the digital filter. Turn off the digital filter. Turn the “Universal knob” to adjust them.
Type	\leftarrow \rightarrow f \uparrow \rightarrow f \leftarrow \rightarrow f \leftarrow \rightarrow f	Setup as LPF (Low Pass Filter). Setup as HPF (High Pass Filter). Setup as BPF (Band Pass Filter). Setup as BRF (Band Reject Filter).
Upper_limit		Turn the “Universal” knob to set upper limit.
Lower_limit		Turn the “Universal” knob to set lower limit.
Return		Return the digital filter main menu.

Functional Description

VERTICAL System (cont'd)

Knobs in the « VERTICAL » mode

Vertical "POSITION" knob

1. Use the Vertical "POSITION" knobs to move the channel waveforms up or down on the screen.
2. When you adjust the vertical position of channels waveforms, the vertical position information will be displayed on the bottom left of screen.
3. Press the vertical "POSITION" knob to set the vertical position to zero.

Volts/div knob

1. Use the "Volts/div" knobs to control how the oscilloscope amplifies or attenuates the source signal of channel waveforms. When you turn the "volts/div" knob, the oscilloscope increases or decreases the vertical size of the waveform on the screen with respect to the ground level;
2. When you press the "Volt/div" Knob, you can switch "Volt/div" option between "Coarse" and "Fine". The vertical scale is ensured by the 1-2-5 step in Coarse mode. In the fine mode, the knob changes the Volts/Div scale into small steps between the coarse settings.

www.electronicsemba.com

Functional Description

VERTICAL System (cont'd)



MATH functions

This shows the results after +, -, * and FFT operation of the CH1 and CH2.

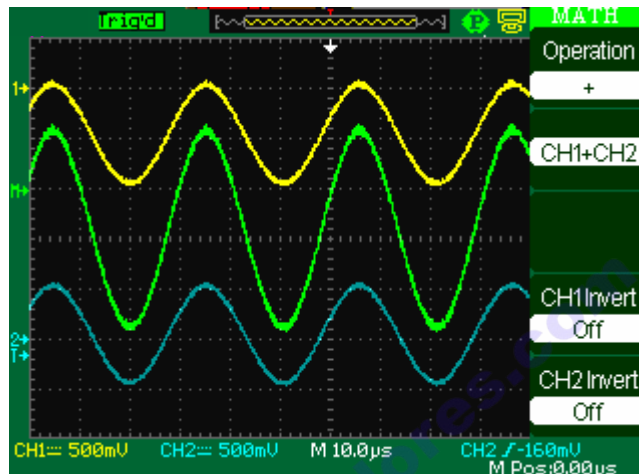
Press the MATH button to display the waveform math operations.



MATH function menu

Function	Setting	Description
Operation	+, -, *, FFT	Choose MATH operations.
CH1 Invert	on off	Invert the CH1 waveform. Turn off CH1 Invert function.
CH2 Invert	on off	Invert the CH2 waveform. Turn off CH2 Invert function.
		By rotating the universal knob to adjust the vertical position of waveform after operation
		By rotating the universal knob to adjust the vertical range of waveform after operation

MATH function instruction

Operation	Setting	Description
+	CH1+CH2	CH1 adds CH2.
-	CH1-CH2	CH2 is subtracted from CH1.
	CH2-CH1	CH1 is subtracted from CH2.
*	CH1*CH2	CH1 multiplies CH2.
/	CH1/CH2	CH1 divides CH2.
	CH2/CH1	CH2 divides CH1.
FFT	Fast Fourier Transform.	

Functional Description

VERTICAL System (cont'd)

FFT Spectrum Analyser

The FFT process mathematically converts a time-domain signal into its frequency components.

You can take two measurements on FFT spectrums: magnitude (in dB) and frequency (in Hz).

FFT function menu 1

FFT Option	Setting	Description
Source	CH1 CH2	Select this channel as the FFT source.
Window	Hanning Hamming Rectang. Blackman	Select FFT window types.
FFT ZOOM	1 x 2 x 5 x 10 x	Changes the horizontal magnification of the FFT display. Uses cursors to take measurements of the FFT spectrum.

FFT function menu 2

FFT Option	Setting	Description
Scale	Vrms	Set Vrms to be the Vertical Scale unit.
	dBVrms	Set dBVrms to be the vertical Scale unit.
Display	Split	Display FFT waveform on half screen.
	Full screen	Display FFT waveform on full screen.

Select FFT window

Window	Speciality	Satisfied Test content
Rectangular	Best frequency resolution, worst magnitude resolution. This is essentially the same as no window.	Symmetric transients or bursts. Equal-amplitude sine waves with fixed frequencies. Broadband random noise with a relatively slowly varying spectrum.
Hanning Hamming	Better frequency, poorer magnitude accuracy than Rectangular. Hamming has slightly better frequency resolution than Hanning.	Sine, periodic, and narrow-band random noise. Asymmetric transients or bursts.
Blackman	Best magnitude, worst frequency resolution.	Single frequency waveforms, to find higher order harmonics.

Functional Description

VERTICAL System (cont'd)

Measuring an FFT Spectrum using cursors

You can take two measurements on FFT spectrums : magnitude (in dB) and frequency in Hz.

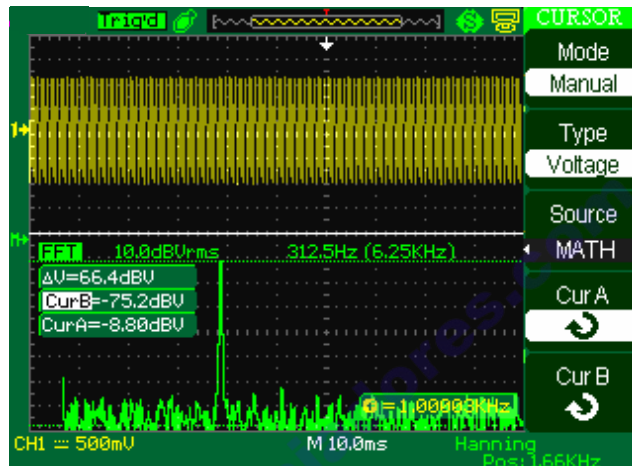

Measuring an FFT amplitude

Once viewed the spectrum :

1. Press the "CURSOR" button to enter "Cursor" menu.
2. Press "Cusor Mode" to select "Manual".
3. Press "Type" to select "Voltage".
4. Press "Source" to select "MATH".
5. Press "CurA", turn the "Universal" knob to move Cursor A to the highest point of the FFT waveform.
6. Press "CurB", turn the "Universal" knob to move Cursor B to the lowest point of the FFT waveform.
7. The amplitude (ΔT) is displayed at the top right of the screen.

Functional Description

VERTICAL System (cont'd)

Measuring FFT frequency

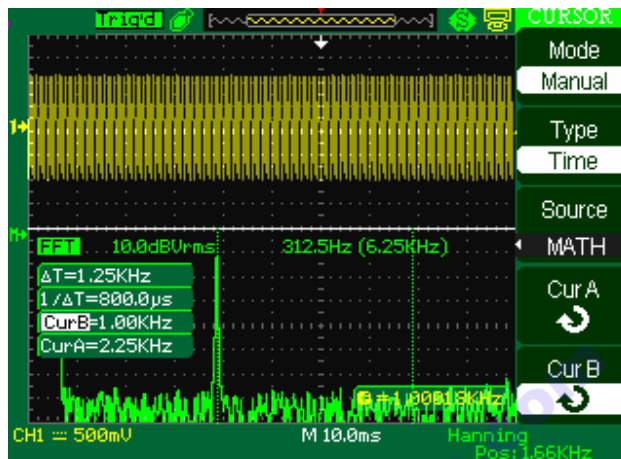

1. Press the CURSOR button.
2. Press "Cursor Mode" to select "Manual".
3. Press "Type" to select "Time".
4. Press "Source" to select "MATH".
5. Press "Cur1", turn the "Universal" button to move Cursor 1 to the highest position of the FFT waveform.
6. The value of Cur1 displaying on the top right of the screen is FFT highest Frequency. This frequency should be the same as input signal frequency.

Note To display FFT waveforms with a large dynamic range, use the dBVrms scale. The dBVrms scale displays component magnitudes using a log scale.

Functional Description

VERTICAL System (cont'd)

Using REF

The reference control saves waveforms to a non-volatile waveform memory. The reference function becomes available after a waveform has been saved.

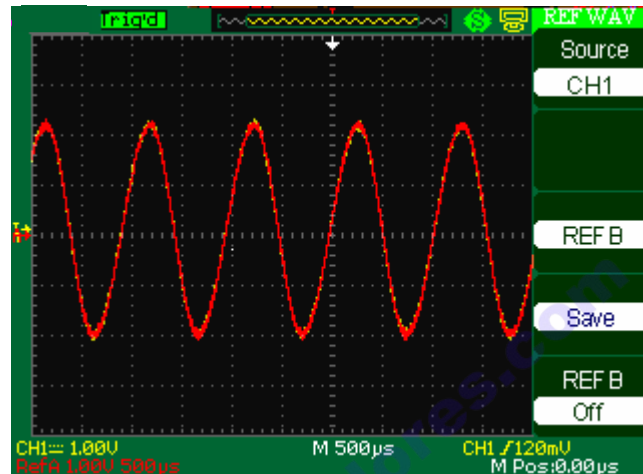

REF function menu

Press the « REF » button.

Option	Setting	Introduction
Source	CH1 CH2 CH1 off CH2 off	Choose the waveform display to store.
REFA REFB		Choose the reference location to store or recall a waveform.
Save		Stores source waveform to the chosen reference location.
REFA/REFB	on off	Recall the reference waveform on the screen. Turn off the reference waveform.

Functional Description

HORIZONTAL System

HORIZONTAL System

Horizontal system function menu

Option	Setting	Description
Delayed	On	Turn on this function in order to simultaneously display the main waveform time base on the top half of the screen and the window time base waveform on the bottom half of the screen
	Off	Turn off this function in order to display only the main waveform time base on the screen.
MemDepth	Normal	Set memory depth to normal (32 kpts).
	Long Mem	Set memory depth to long Memory depth in order to get more waveform dots (2 Mpts).

Note

Only XDO2040 series supports Long Memory.

Functional Description

HORIZONTAL System (cont'd)

Knobs in the « Horizontal » mode

Horizontal “POSITION” knob

You can use the horizontal controls to change the horizontal scale and position of waveforms.

1. Adjust the horizontal position of all channels and math waveforms (the position of the trigger relative to the centre of the screen). The resolution of this control varies with the time base setting.
2. When you press the horizontal “POSITION” knob, you can set the horizontal position to zero.

S/div knob

1. Using to change the horizontal time scale to magnify or compress the waveform. If waveform acquisition is stopped (using the RUN/STOP or SINGLE button), turn the S/div knob to expand or compress the waveform.
2. Select the horizontal time/div (scale factor) for the main or the window time base. When Window Zone is enabled, it changes the width of the window zone by changing the window time base.

Display scan mode

When the SEC/DIV control is set to 100 ms/div or slower and the trigger mode is set to Auto, the oscilloscope enters the scan acquisition mode. In this mode, the waveform display updates from left to right. There is no trigger or horizontal position control of waveforms during scan mode.

Delayed

Use the Window Zone option to define a segment of a waveform to see more detail. The Window time base setting cannot be set slower than the Main time base setting.

You can turn the Horizontal Position and SEC/DIV controls to enlarge or diminish waveforms in the Window Zone.

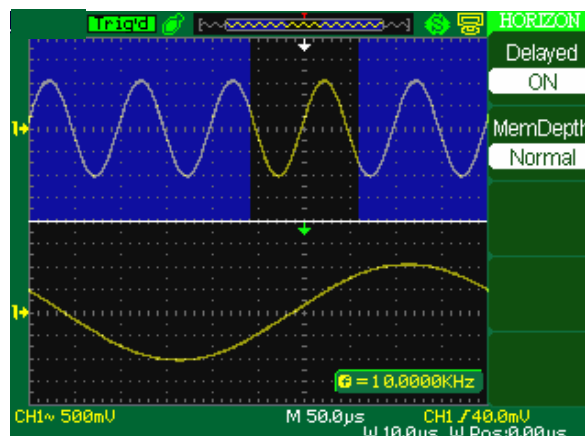

Follow these steps

if you want to see a section of the waveform in detail :

1. Press the “HORI MENU” button to enter the “Horizontal menu”.
2. Turn the “S/div” knob to change the main timebase scale.
3. Press the “Delayed” option button to select “On”.

Turn the “Horizontal Position” knob (adjust window’s position) to select the window that you need and expanded window waveform display on the below half screen at the same time.

Functional Description

TRIGGER System

TRIGGER System

The trigger determines when the oscilloscope starts to acquire data and to display a waveform.

XDO series has five trigger type : Edge, Video, Pulse, Slope, Alternative

Signal source

The source can be any signal connected to a channel BNC, to the EXT TRIG BNC or the AC power line (available only with Edge triggers).

Edge Trigger

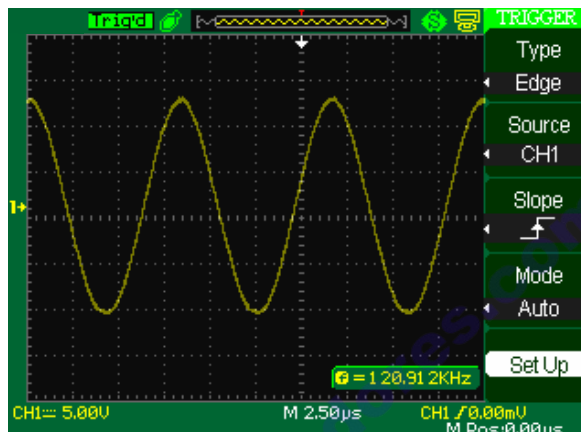

EdgeTrigger function menu

Option	Setting	Description
Type	Edge	With Edge highlighted, the rising or falling edge of the input signal is used for the trigger.
Source	CH1 CH2	Triggers on a channel whether or not the waveform is displayed.
	EXT	Does not display the trigger signal; the Ext option uses the signal connected to the EXT TRIG front-panel BNC and allows a trigger level range of -1.2V to +1.2V.
	EXT/5	Same as Ext option, but attenuates the signal by a factor of five, and allows a trigger level range of +6V to -6V. This extends the trigger level range.
	AC Line	This selection uses a signal derived from the power line as the trigger source; trigger coupling is set to DC and the trigger level to 0V.
Slope		Trigger on Rising edge of the trigger signal.
		Trigger on Falling edge of the trigger signal.
		Trigger on Rising and Falling edge of the trigger signal.
Mode	Auto	The waveform refreshes a high-speed whether the trigger condition is satisfied or not
	Normal	The waveform refreshes when the trigger condition is satisfied and waits for next trigger event occurring when the trigger condition is not satisfied.
	Single	The oscilloscope acquires a waveform when the trigger condition is satisfied and then stops.
Set up		Enter the "Trigger Setup Menu".

Functional Description

TRIGGER System (cont'd)

Trigger Setup function menu

Option	Setting	Description
Coupling	DC	Passes all components of the signal
	AC	Blocks DC components and attenuates signals below 10 Hz.
	HF Reject	Attenuates the high-frequency components above 80 kHz.
	LF Reject	Blocks the DC component and attenuates the low-frequency components below 300 kHz.
Holdoff ↻		Using the “universal” knob to adjust holdoff time (sec), the holdoff value is displayed.
Holdoff Reset		Reset holdoff time to 100 ns.
Return		Return the first page of “Trigger main menu”.





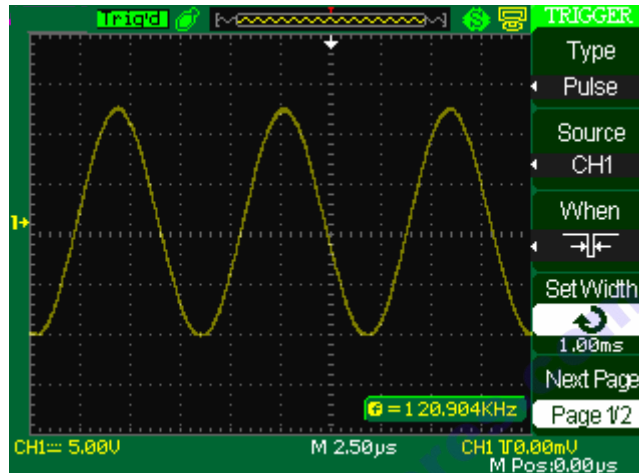

Functional Description

TRIGGER System (cont'd)

Pulse Trigger

*Pulse Trigger
function menu 1*



Option	Setting	Description	
Type	Pulse	Select the pulse to trigger the pulse match the trigger condition.	
Source	CH1 CH2 EXT EXT/5	Select input signal source.	
When	     	(Positive pulse width less than pulse width setting) (Positive pulse width larger than pulse width setting) (Positive pulse width equal to pulse width setting) (Negative pulse width less than pulse width setting) (Negative pulse width larger than pulse width setting) (Negative pulse width equal to pulse width setting)	Select how to compare the trigger pulse relative to the value selected in the Set Pulse Width option.
Set Width	20.0ns to 10.0s	Selecting this option can turn the universal to set up the pulse width.	

Functional Description

TRIGGER System (cont'd)

Pulse Trigger function menu 2

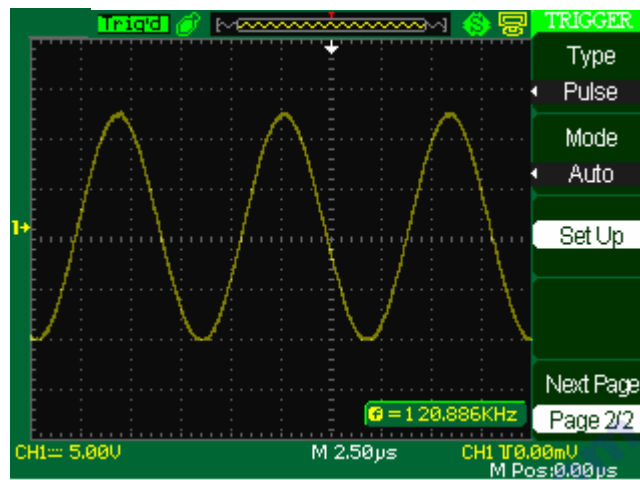



Option	Setting	Description
Type	Pulse	Select the pulse to trigger the pulse match the trigger condition.
Mode	Auto Normal Single	Select the type of triggering; Normal mode is best for most Pulse Width trigger applications.
Set up		Enter the "Trigger setup menu".

Functional Description

TRIGGER System (cont'd)

Video Trigger

Video Trigger 1 function menu

Option	Setting	Instruction
Type	Video	When you select the video type, set the AC coupling, it then becomes possible to trigger the NTSC, PAL and SECAM video signal.
Source	CH1 CH2	Select the input source to be the trigger signal.
	EXT EXT/5	Ext and Ext/5 use the signal applied to the EXT TRIG connector as the source.
Polarity	 (normal)	Normal triggers on the negative edge of the sync pulse.
	 (inverted)	Inverted triggers on the positive edge of the sync pulse.
Sync	Line Num All lines Odd field Even Field	Select appropriate video sync.

Functional Description

TRIGGER System (cont'd)

Video Trigger 1 function menu

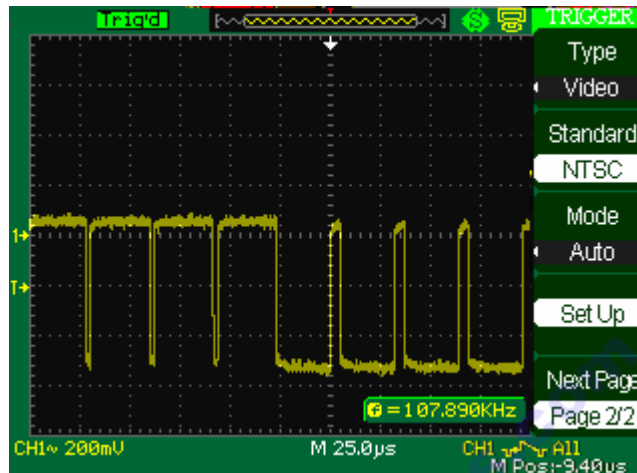

Option	Setting	Instruction
Type	Video	When you select the video type, set the AC coupling, then you could trigger the NTSC, PAL and SECAM video signal.
Standard	NTSC Pal/ Secam	Select the video standard for sync and line number count.
Mode	Auto	Use this mode to let the acquisition run in the absence of a valid trigger; This mode allows an untriggered, scanning waveform at 100 ms/div or slower time base settings.
	Normal	Use this mode when you want to see only valid triggered waveforms; when you use this mode, the oscilloscope does not display a waveform until after the first trigger.
	Single	When you want the oscilloscope to acquire a single waveform, press the "SINGLE" button.
Set up		Enter the "Trigger setup menu".

Functional Description

TRIGGER System (cont'd)

Slope Trigger

*Slope Trigger
function menu 1*

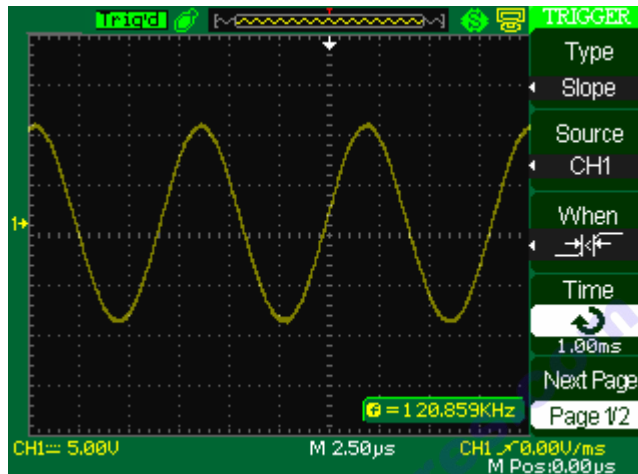

Option	Setting	Instruction
Type	Slope	Trigger on positive slope of negative slope according to setup time of the oscilloscope.
Source	CH1 CH2 EXT EXT/5	Select trigger source.
When		Select trigger condition.
Time	 (Set time)	Turn the "Universal" knob to set slope time. Time setup range is 20 ns -10 s.

Functional Description

TRIGGER System (cont'd)

Slope Trigger function menu 2

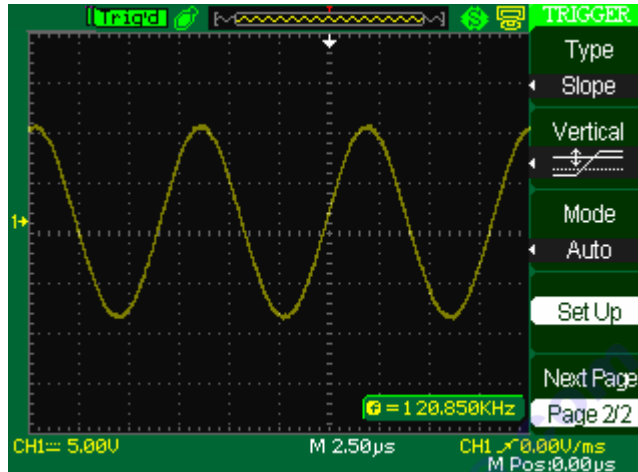

Option	Setting	Instruction
Type	Slope	Trigger on positive slope of negative slope according to setup time of the oscilloscope.
Vertical		Select the trigger level that can be adjusted by "LEVEL" knob. You can adjust "LEVEL A", "LEVEL B" or adjust them at the same time.
Mode	Auto	Use this mode to let the acquisition run in the absence of a valid trigger; This mode allows an untriggered, scanning waveform at 100 ms/div or slower time base settings.
	Normal	Use this mode when you want to see only valid triggered waveforms; when you use this mode, the oscilloscope does not display a waveform until after the first trigger.
	Single	when you want the oscilloscope to acquire a single waveform, press the "SINGLE" button.
Set up		Enter the "Trigger setup menu".

Functional Description

TRIGGER System (cont'd)

Alternative Trigger

The trigger signal comes from two vertical channels when you use the alternative trigger. In this mode, you can observe two irrelative signals at the same time. You can select different trigger types for two vertical signals and selected types cover edge, pulse, video and slope trigger. Trigger information for the two channel signals is displayed at the bottom right of the screen.

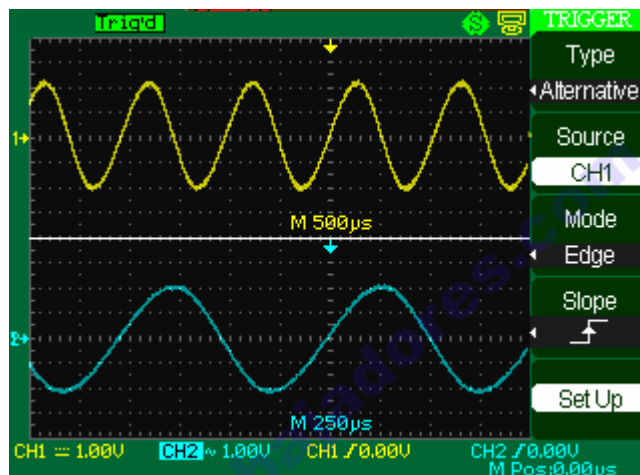

Edge Trigger function menu

Option	Setting	Instruction
Type	Alternative	The trigger signal comes from two vertical channels when you use alternative trigger. In this mode you can observe two irrelative signals at the same time.
Source	CH1 CH2	Set trigger type information for CH1 signal Set trigger type information for CH2 signal
Mode	Edge	Set trigger type of the vertical channel signal to Edge
Slope	↗	Triggering on rising edge.
	↘	Triggering on falling edge.
	↕	Triggering on rising edge and falling edge.
Set up		Enter the "Trigger setup menu".

Functional Description

TRIGGER System (cont'd)

Pulse Trigger function menu 1

Option	Setting	Instruction
Type	Alternative	The trigger signal comes from two vertical channels when you use alternative trigger. In this mode, you can observe two irrelative signals at the same time.
Source	CH1 CH2	Set trigger type information for CH1 signal Set trigger type information for CH2 signal
Mode	Pulse	Set trigger type of the vertical channel signal to Pulse trigger.
When		Select how to compare the trigger pulse relative to the value selected in the Set Pulse Width option.



Pulse Trigger function menu 2

Option	Setting	Description
Set Width	20.0ns ~10.0s	Selecting this option can turn the universal to set up the pulse width.
Set up		Enter the "Trigger Setup Menu"

Functional Description

TRIGGER System (cont'd)

Video Trigger function menu 1

Option	Setting	Instruction
Type	Alternative	The trigger signal comes from two vertical channels when you use alternative trigger. In this mode, you can observe two non-related signals at the same time.
Source	CH1 CH2	Set trigger type information for CH1 signal Set trigger type information for CH2 signal
Mode	Video	Set trigger type of the vertical channel signal to Video trigger.
Polarity	 (normal)  (inverted)	Normal triggers on the negative edge of the sync pulse. Inverted triggers on the positive edge of the sync pulse.

Video Trigger function menu 2

Option	Setting	Instruction
Sync	Line Num All lines Odd field Even Field	Select appropriate video sync.
Standard	NTSC Pal/Secam	Select the video standard for sync and line number count.



Functional Description

TRIGGER System (cont'd)

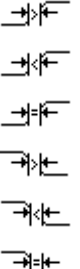
Slope Trigger function menu 1

Option	Setting	Instruction
Type	Alternative	The trigger signal comes from two vertical channels when you use alternative trigger. In this mode, you can observe two non-related signals at the same time.
Source	CH1 CH2	Set trigger type information for CH1 signal Set trigger type information for CH2 signal
Mode	Slope	Set trigger type of the vertical channel signal to slope trigger.
When		Select slope trigger condition.

Slope Trigger function menu 2

Option	Setting	Instruction
Time	 (Set time)	Turn the "Universal" knob to set the slope time. Time setup range is 20 ns - 10 s.
Vertical		Select the trigger level that can be adjusted by "LEVEL" knob. You can adjust "LEVEL A", "LEVEL B" or adjust them at the same time.
Set up		Enter the "Trigger setup menu".

Functional Description

TRIGGER System (cont'd)

Follow these steps to observe two irrelative channel signals :

1. Input two irrelative signals to channel 1 and channel 2.
2. Press the AUTO button.
3. Press TRIG MENU to enter "trigger menu".
4. Press "Type" to select "Alternative".
5. Press "Source" to select "CH1".
6. Press "S/div" to optimize waveform display.
7. Press "Mode" to select "Edge", "Pulse", "Slope" or "Video".
8. Set the trigger according to trigger edge.
9. Press "Source" to select "CH2".
10. Turn "S/div" to optimize waveform display.
11. Repeat steps 7 and 8.

www.electronicabaiadros.com

Functional Description

TRIGGER System (cont'd)

Trigger Holdoff

You can use the Trigger Holdoff function to produce a stable display of complex waveforms. Holdoff is the time between when the oscilloscope detects one trigger and when it is ready to detect another one.

If you want to change the holdoff time, follow these steps:

1. Press the "TRIG MENU" button to show the "TRIG Menu".
2. Press "Type" to select trigger type.
3. Press "Set up" to enter the "Trigger setup menu".
4. Press "Holdoff" and turn the "Universal" knob to change the holdoff time until the waveform trigger steadily.

www.electronicaembajadores.com

Functional Description

ACQUISITION System

Acquiring Signal System

When you acquire a signal, the oscilloscope converts it into a digital form and displays a waveform. The acquisition mode defines how the signal is digitized and the time base setting affects the time span and level of detail for the acquisition.

Press the “ACQUIRE” button.

Acquiring signal function menu

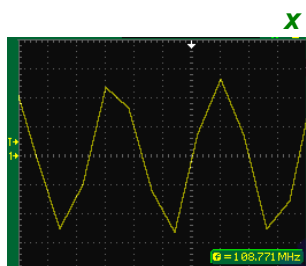
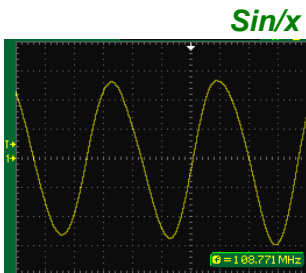

Option	Setting	Description
Acquisition	Sampling	Use for sampling and accurately display most of the waveform.
	Peak Detect	Detect the noise and decrease the possibility of aliasing.
	Average	Use to reduce random or uncorrelated noise in the signal display.
	Averages 4, 16, 32 64, 128, 256	Select number of averages.
Sin/x	Sin/x	Sinusoidal Interpolation
x	x	Linear Interpolation
Mode	Equ time	Set the Sampling mode to Equ time. The equivalent time sampling mode can achieve up to 20 ps of horizontal resolution (equivalent to 50 GSa/s). This mode is good for observing repetitive waveforms.
	Real time	Set the Sampling mode to Real time. In “Real time” mode, turn the “S/div” knob to display the real time sampling rate at corresponding time base scale; In “Equ time” mode, turn the “S/div” knob to display the equ time sampling rate at corresponding time base scale”.
Sa Rate		Display system sampling rate.

Functional Description

DISPLAY System

DISPLAY System

Display system function menu 1 Press the "DISPLAY" button.

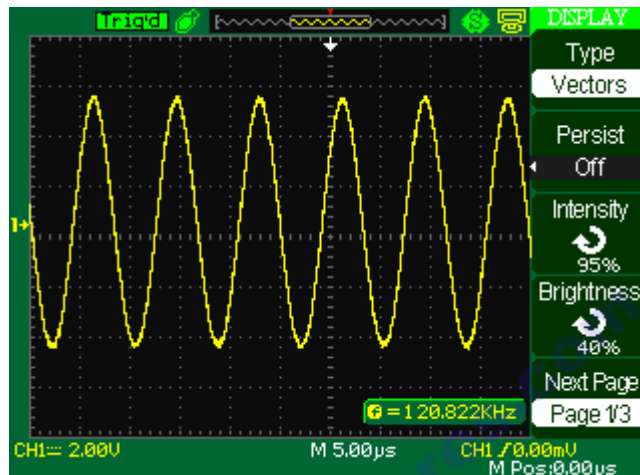





Option	Setting	Description
Type	Vectors	"Vectors" fills the space between adjacent sample points in the display.
	Dots	Dots : display sample points Directly.
Persist	Off	Sets the length of time for which each displayed sample point will be displayed.
	1 sec	
	2 sec	
	5 sec	
	Infinite	
Intensity	↻ <Intensity>	Set waveform intensity.
Brightness	↻ <Intensity>	Set grid brightness.

Functional Description

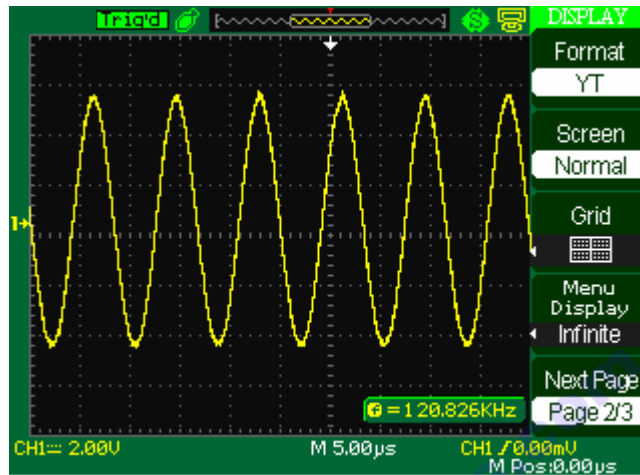
DISPLAY System (cont'd)

*Display system
function menu 2*



Option	Setting	Description
Format	YT	YT format displays the vertical voltage in relation to time (horizontal scale).
	XY	XY format displays a dot each time a sample is acquired on channel 1 and channel 2.
Screen	Normal	Set to normal mode.
	Inverted	Set to invert colour display mode.
Grid		Display grids and axes on the screen.
		Turn off the grids.
		Turn off the grids and axes.
Menu Display	2 sec	Set menu display time on screen.
	5 sec	
	10 sec	
	20 sec	
	Infinite	

Functional Description

DISPLAY System (cont'd)

Display system function menu 3

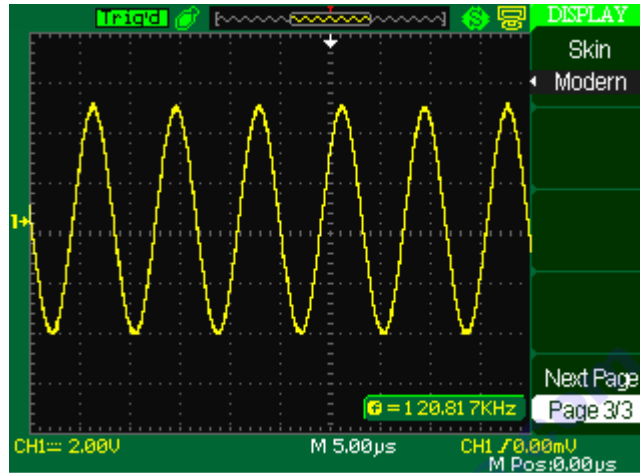

Option	Setting	Description
Skin	Classical Modern Tradition Succinct	Set up screen style.

Functional Description

DISPLAY System (cont'd)

X-Y Format

Use the XY format to analyze phase differences. The format plots the voltage on channel 1 against the voltage on channel 2, where channel 1 is the horizontal axis and channel 2 is the vertical axis. The oscilloscope uses the untriggered Sample acquisition mode and displays data as dots.

Operation steps

- Channel 1 “Volt/div” and vertical “POSITION” set up the horizontal scale and position.
- Channel 2 “Volt/div” and vertical “POSITION” set up the horizontal scale and position.
- Turn the “S/div” knob to adjust the sampling rate (Range : 5 kS/s → 200 MS/s).

Option	Setting	Description
Cursor Mode	Manual	In this menu, set the manual cursor measure.
Type	Voltage Time	Use cursor to measure voltage parameters. ■ Voltage Cursor: Voltage cursors appear as horizontal lines on the display and measure the vertical parameters. Use cursor to measure time parameters. ■ Time Cursor: Time cursors appear as vertical lines on the display and measure the horizontal parameters.
Source	CH1 CH2 MATH REFA REFB	Select input signal channel.
Cur A ↻		Select this option turn the “Universal” knob to adjust cursor A.
Cur B ↻		Select this option turn the “Universal” knob to adjust cursor B.

Functional Description

MEASURE System

The oscilloscope displays the voltage in relation to time and tests the wave form displayed. There are scale, cursor and auto measure modes.

Scale Measurement This method allows you to make a quick visual estimate.

Cursor Measurement The cursor measurement has three modes: Manual, Track and Auto. Press the “CURSOR” button.

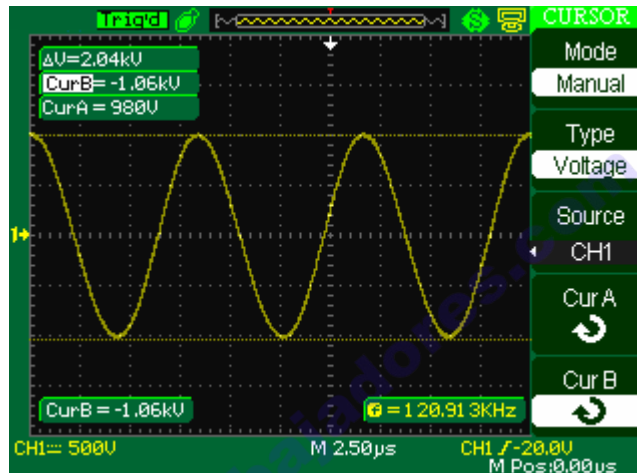

Manual Cursor function menu

Option	Setting	Description
Cursor Mode	Manual	In this menu, set the manual cursor measure.
Type	Voltage Time	Use cursor to measure voltage parameters. Use cursor to measure time parameters.
Source	CH1 CH2 MATH REFA REFB	Select input signal channel.
Cur A ↻		Select this option turn the “Universal” knob to adjust cursor A.
Cur B ↻		Select this option turn the “Universal” knob to adjust cursor B.

Functional Description

MEASURE System (cont'd)

Track mode function menu

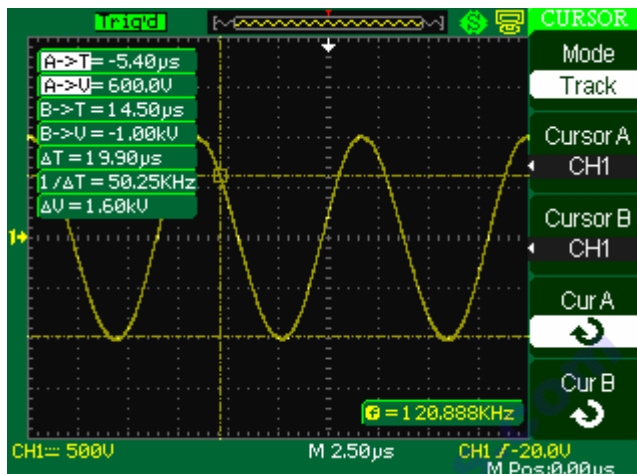

Option	Setting	Description
Cursor Mode	Track	In this mode, set track cursor measure.
Cursor A	CH1 CH2 NONE	Set the input signal channel that the Cursor A will measure.
Cur B	CH1 CH2 NONE	Set the input signal channel that the Cursor B will measure.
Cur A ↺		Select this option, turn the “Universal” knob to adjust horizontal coordinate of Cursor A.
Cur B ↻		Select this option, turn the “Universal” knob to adjust horizontal coordinate of Cursor B.

In this mode, the screen displays two cross cursors. The cross cursor sets the position on the waveform automatically. You can adjust the cursor’s horizontal position on the waveform by turning the “Universal” knob. The oscilloscope displays the values on the top right of the screen.

Functional Description

MEASURE System (cont'd)

Auto mode function menu

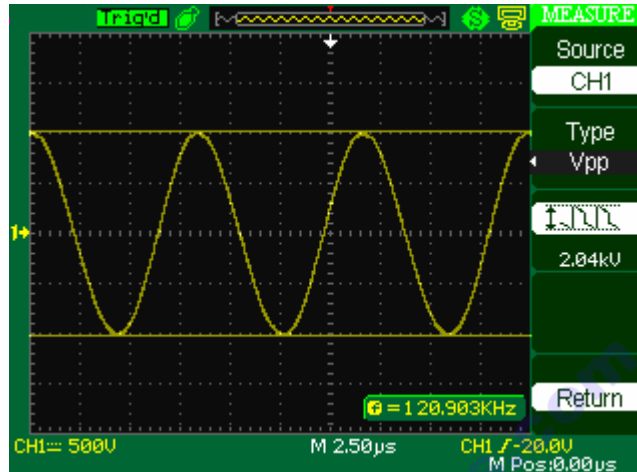

Option	Setting	Description
Cursor Mode	Auto	Set to auto cursor measure mode.

This mode will take effect with automatic measurements.

Follow these steps to perform auto cursor measurements :

1. Press the CURSOR button to enter "Cursor measure menu".
2. Press the "Cursor Mode" option button to select "Auto".
3. Press the "MEASURE" button to enter "Auto cursor measure mode menu" to select the parameter that you want to measure.

Functional Description

MEASURE System (cont'd)

Auto Measurement

Press the 'MEASURE' button for the Automatic Test.

There are three auto measurement types: Voltage Measure, Time Measure and Delay Measure. There are 32 measure parameters.

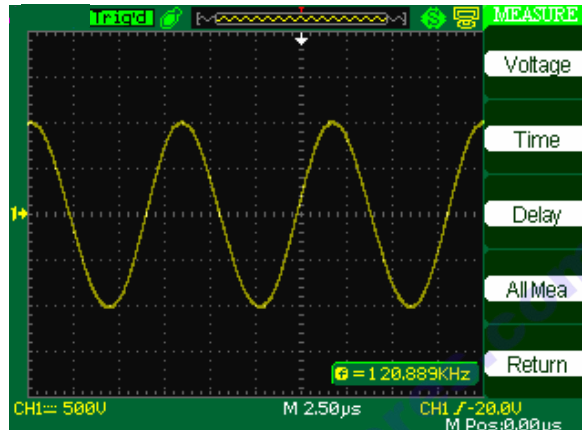

Auto measure function menu 1

Option	Instruction
Voltage	Press this button to enter the Voltage measure menu.
Time	Press this button to enter the Time measure menu.
Delay	Press this button to enter the Delay measure menu.
All Mea	Press this button to enter the All Measurement menu.
Return	Press this option button to return the home page of the auto measure menu.

Auto measure function menu 2 : Voltage measure menu

Option	Setting	Instruction
Source	CH1 CH2 MATH REFA REFB	Select input signal source for Voltage measure.
Type	Vmax, Vmin, Vpp, Vamp, Vtop, Vbase, Cycle Mean, Mean, Cycle Vrms, Vrms, ROVShoot, FOVShoot, RPRESshoot, FPRESshoot	Press the "Type" button or turn the "Universal" knob to select Voltage measure parameter.
		Display the corresponding icon and measure value of your selected Voltage measure parameter.
Return		Return to the first page of auto measurement menu.

Functional Description

MEASURE System (cont'd)

*Auto measure
function menu 3
Time measure
menu*

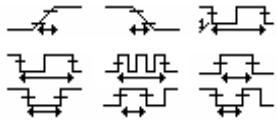
Option	Setting	Instruction
Source	CH1 CH2 MATH REFA REFB	Select input signal source for Voltage measure.
Type	Rise Time Fall Time Freq Period BWidth +Width -Width +Duty -Duty	Press the "Type" button or turn the "Universal" knob to select Voltage measure parameter.
		Display the corresponding icon and measure value of your selected Voltage measure parameter.
Return		Return to the first page of auto measurement menu.

*Auto measure
function menu 4
Delay measure
menu*

Option	Setting	Instruction
Source	CH1 CH2 MATH REFA REFB	Select input signal source for Delay measure.
Type	Phase FRR FRF FFR FFF LRR LRF LFR LFF	Press the "Type" button or turn the "Universal" knob to select Delay measure parameter.
		Display the corresponding icon and measure value of your selected Delay measure parameter.
Return		Return to the first page of auto measurement menu.











Functional Description

MEASURE System (cont'd)

All measurement function menu

Option	Setting	Description
Source	CH1 CH2	Select input signal channel.
Voltage	On Off	Turn on the all measurement function to measure voltage parameters. Turn off the all measurement function to measure voltage parameters.
Time	On Off	Turn on the all measurement function to measure Time parameters. Turn off the all measurement function to measure Time parameters.
Delay	On Off	Turn on the all measurement function to measure Delay parameters. Turn off the all measurement function to measure Delay parameters.
Return		Return to the "All Measure main menu".





















Introduction of the measure type

Measure Type	Description
 Vmax	The most positive peak voltage measured over the entire waveform.
 Vmin	The most negative peak voltage measured over the entire waveform.
 Vpp	Measures the absolute difference between the maximum and minimum peaks of the entire waveform.
 Vtop	Measures the highest voltage over the entire waveform.
 Vbase	Measures the lowest voltage over the entire waveform.
 Vamp	Voltage between Vhigh and Vlow of a waveform.
 Vavg	The arithmetic mean over the first cycle in the waveform.
 Mean	The arithmetic mean over the entire waveform.
 Crms	The true Root Mean Square voltage over the first cycle in the waveform.
 Vrms	The true Root Mean Square voltage over the entire waveform.

Functional Description

MEASURE System (cont'd)

All measurement
function menu
(cont'd)

 ROVShoot	Defined as $(V_{max}-V_{hig})/V_{amp}$ after the waveform rising.
 FOVShoot	Defined as $(V_{min}-V_{low})/V_{amp}$ after the waveform falling.
 RPREshoot	Defined as $(V_{min}-V_{low})/V_{amp}$ before the waveform rising.
 FPREshoot	Defined as $(V_{max}-V_{hig})/V_{amp}$ before the waveform falling.
 Rise Time	Rise Time Measures the time between 10% and 90% of the first rising edge of the waveform.
 Fall Time	Fall Time Measures the time between 90% and 10% of the first falling edge of the waveform.
 BWid	The duration of a burst. Measured over the entire waveform.
 + Wid	+ Width Measures the time between the first rising edge and the next falling edge at the waveform 50% level.
 - Wid	-Width Measures the time between the first falling edge and the next rising edge at the waveform 50% level.
 + Duty	Measures the first cycle waveform. Positive Duty Cycle is the ratio between positive pulse width and period.
 - Duty	Measures the first cycle waveform. Negative Duty Cycle is the ratio between negative pulse width and period.
 Phase	The amount one waveform leads or lags another in time. Expressed in degrees, where 360 degrees comprise one waveform cycle.
 FRR	The time between the first rising edge of source 1 and the first rising edge of source 2.
 FRF	The time between the first rising edge of source 1 and the first falling edge of source 2.
 FFR	The time between the first falling edge of source 1 and the first rising edge of source 2.
 FFF	The time between the first falling edge of source 1 and the first falling edge of source 2.
 LRR	The time between the first rising edge of source 1 and the last rising edge of source 2.
 LRF	The time between the first rising edge of source 1 and the last falling edge of source 2.
 LFR	The time between the first falling edge of source 1 and the last rising edge of source 2.
 LFF	The time between the first falling edge of source 1 and the last falling edge of source 2.

Functional Description

STORAGE System

STORAGE System

The XDO series can save 2 group reference waveforms, 20 group setups and 20 group waveforms to the oscilloscope's internal memory. There is a USB Host interface on the front panel of the oscilloscope and it is possible to save setup data, waveform data, waveform interface image, CSV file to a USB flash drive. Setup data and waveform data can be recalled to the current oscilloscope or the other same model oscilloscopes. Picture data and CSV files can't be recalled to the oscilloscope, but can be opened on the adequate computer software. CSV files saved on the USB drive are formatted in sec. and volts.

SAVE / RECALL setup

Interface

The screenshot shows a file management screen with a list of files and folders. The top bar indicates 'A:1' and 'Free: 238 MB'. The file list includes:

10000ц~1.XLS	4.72 MB
A.CSV	1.28 MB
ADS100~1.XLS	331 KB
AEACE2~1.ADS	889 KB
B.CSV	1.28 MB
C.CSV	648 KB
D.CSV	14.0 KB
E.CSV	292 KB
F.CSV	506 KB

On the right side, there is a 'SAVE ALL' menu with the following options:

- Modify
- Directories (Select operating object)
- New Folder (Create new needed folder)
- Del Folder (Delete present folder)
- Load
- Next Page
- Page 1/2

A note at the bottom of the screen reads: 'Use the adjust knob to choose the file and folder'.

The screenshot shows the same file management screen as above. The file list is identical. The 'SAVE ALL' menu on the right has the following options:

- Modify
- Files (Select operating object)
- New File (Create new files in present directories)
- Delete File (Delete present file)
- Load (Recall stored files or present settings)
- Next Page
- Page 1/2

A note at the bottom of the screen reads: 'Use the adjust knob to choose the file and folder'.

Functional Description

STORAGE System (cont'd)

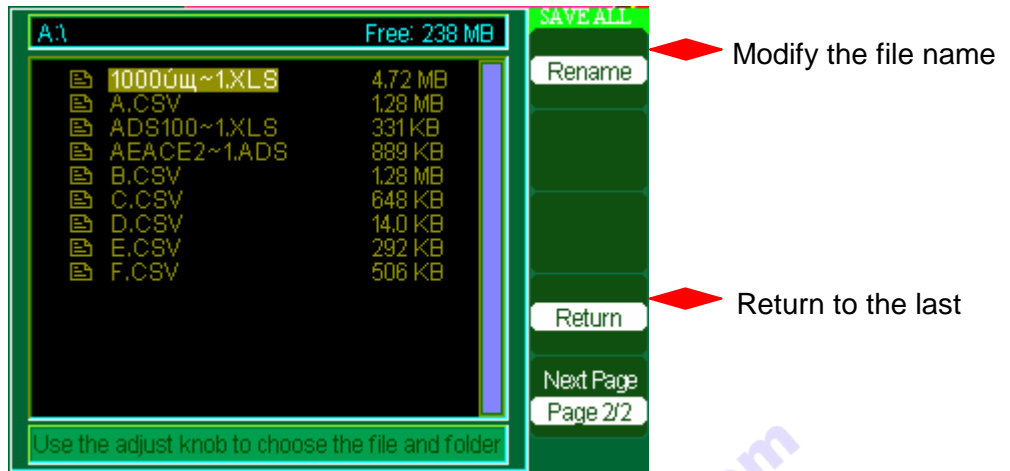

Save / Recall setups

The complete setup is stored in non-volatile memory.

The oscilloscope saves the current setup provided you wait three seconds after the last change before powering off the oscilloscope. The oscilloscope will recall this setup the next time you turn it on. Press the “SAVE / RECALL” button.

Save / Recall setups to device

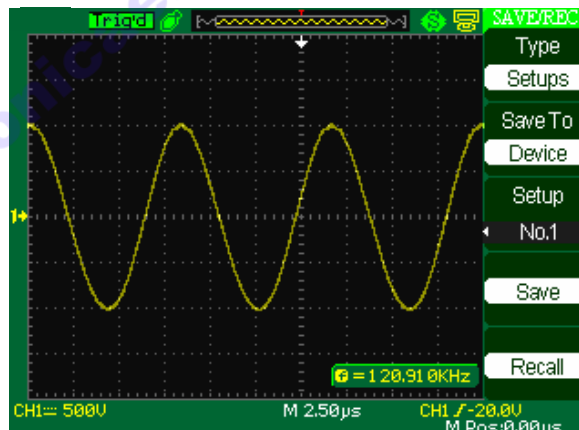

Option	Setting	Description
Type	Setups	Menu for the Save / Recall setting in the oscilloscope
Save to	Device	Save setup to the oscilloscope's internal memory.
Setup	No.1 to No.20	Press the “Setup” option button or turn the “universal” knob to select storage position.
Save		Perform the save
Recall		Recall the storage in the “Setup” operation

Functional Description

STORAGE System (cont'd)

Follow these steps To save setups to the oscilloscope's internal memory or to recall saved setups.

For example: to save the setup so that the oscilloscope displays the waveform as "Dots" to the oscilloscope's internal memorizer.

1. Press the "SAVE/RECALL" button to enter the "SAVE/RECALL" menu.
2. Press the "Type" option button to select "setups".
3. Press the "Save to" option button to select "Device".
4. Press the "Setup" option button to select "No.1".
5. Press the "DISPLAY" button to enter the "Display" menu.
6. Press the "Type" option button to select "Dots".
7. Press the "SAVE/RECALL" button to enter the "SAVE/RECALL" menu.
8. Press the "Save" option button.

Follow these steps if the display type has been changed and you want to recall this setup :

1. Press the "SAVE/RECALL" button to enter the "SAVE/RECALL" display menu.
2. Press the "Type" option button to select "Setups".
3. Press the "Save to" option button to select "Device".
4. Press the "Setup" option button or turn the "Universal" knob to select "No.1".
5. Press the "Recall" option button.

Save / Recall setups to USB flash drive

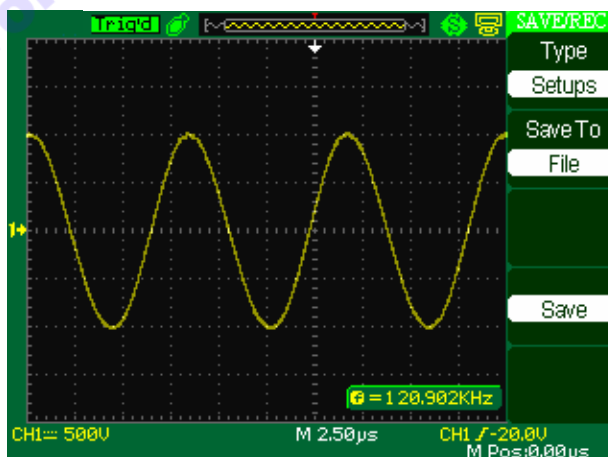

Option	Setting	Introduction
Type	Setups	Menu for the Storage/Recall settings.
Save to	File	Save setup data to USB flash drive.
Save		Go to the Save/Recall interface

Functional Description

STORAGE System (cont'd)

Follow these steps To save setups to the USB flash drive :

For example: to save setup so that the oscilloscope displays the waveform as "Dots" to the oscilloscope's internal memory.

1. Press the "SAVE/RECALL" button to select "Setups".
2. Press the "Save to" button to select "file".
3. Insert the USB drive.
4. Press the "Save" button, then go to the Save/Recall interface.
5. Press the "New folder" button to create a new folder
6. Press "Del folder" to delete a folder
7. Press "Modify" to modify a folder.
8. Press "New file" to create a new file
9. Press "Del file" to delete a file
10. Press "the next page" and press the "Rename" to change the name of the file or the folder.
11. Press "Confirm" to save the setting to the USB drive.
12. Press the "SAVE/RECALL" button before removing the USB drive.

Follow these steps To recall setups data from USB flash drive :

For example: To recall a setup so that the oscilloscope will display the waveform as "Dots" from the oscilloscope's internal memory.

1. Press the "SAVE/RECALL" button.
2. Press the button to select "Setups".
3. Press the "Save to" option and select "file".
4. Press "Save" and go to the Save/Recall interface
5. Choose the file you want to load then press the "Load" button.

Functional Description

STORAGE System (cont'd)

Recall Factory To recall the factory setup :

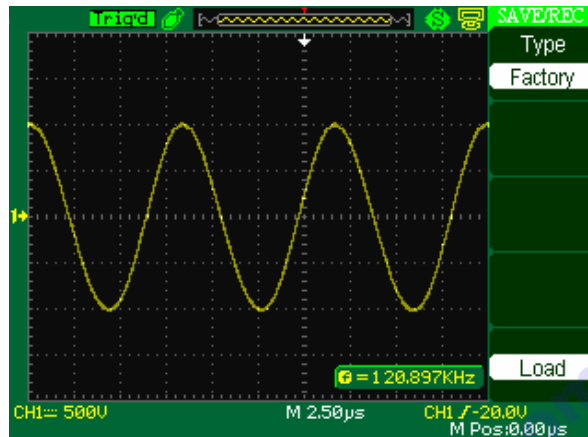

Option	Setting	Description
Type	Factory	To view the Factory setup.
	Load	Recall the Factory setup.

Save / Recall waveform

The oscilloscope will display the waveforms that you want to save. The oscilloscopes can store twenty captured waveforms to a non volatile memory.

Save / Recall waveform

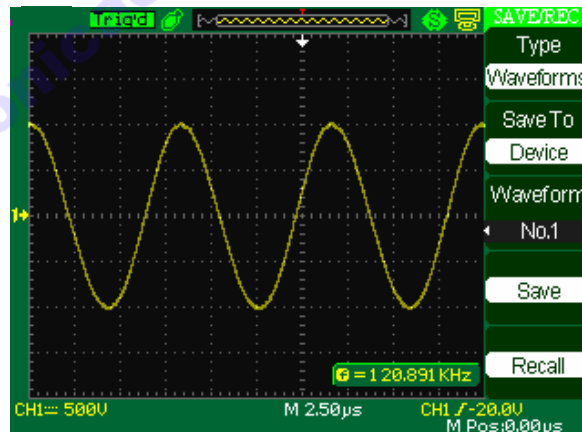

Option	Setup	Description
Type	waveforms	Menu for the Save / Recall of waveforms in the oscilloscope.
Save to	Device	Saves waveforms to the oscilloscope's internal memory.
waveform	No. 1 to No. 20	Press the "waveform" option button or turn the "Universal" knob to select storage position.
Save		Perform the storage.
Recall		Recall the storage in the "waveform" operation

Functional Description

STORAGE System (cont'd)

Follow these steps

To save a waveform to the internal memory:

1. Press the "SAVE/RECALL" button to enter "SAVE/RECALL" display menu.
2. Press the "Type" button to select "waveforms".
3. Press "Save to" to select "Device".
4. Press "waveform" or turn the "Universal" knob to select "No.1".
5. Turn the "Volts/div" knob or "S/div" knob to adjust the waveform that you want to save.
6. Press "Save".

Follow these steps

To recall a saved waveform from the internal memory:

1. Press the "SAVE/RECALL" button to enter "SAVE/RECALL" display menu.
2. Press "Type" to select "waveforms".
3. Press "Save to" to select "Device".
4. Press "waveform" or turn the "Universal" knob to select "No.1".
5. Press "Recall".

Save / Recall waveform to USB flash drive

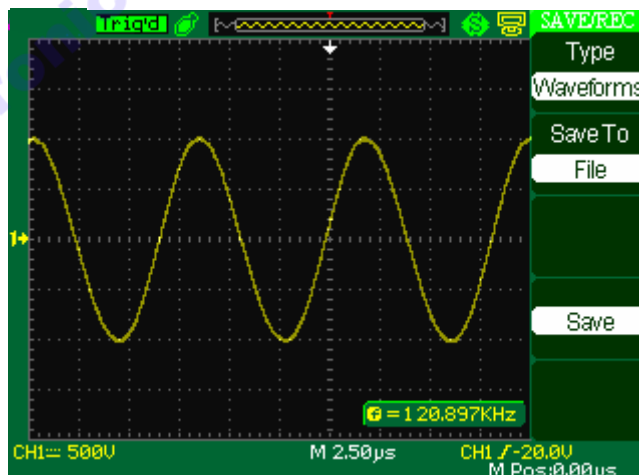

Option	Setup	Description
Type	Waveforms	Menu for the Storage/Recall waveforms.
Save to	File	Save waveforms to USB flash drive.
Save		Accomplish the storage.

Functional Description

STORAGE System (cont'd)

Follow these steps

To save a waveform to a USB flash drive :

1. Input a sine signal to channel 1, press the “AUTO” button.
2. Press “SAVE/RECALL” to enter the “SAVE/RECALL” display menu.
3. Press “Type” to select “Waveforms”.
4. Insert the USB flash drive.
5. Press “Save to” to select “File”.
6. Press “Save” to enter the Save/Recall interface.
7. Create a file then press “Confirm” (for about ten seconds).
8. Press “SAVE/RECALL” before removing the USB drive.

Follow these steps

To recall a saved waveform from the USB flash drive :

1. Press the “SAVE/RECALL” button.
2. Press “Type” to select “Waveforms”.
3. Insert the USB flash drive.
4. Press “Save to” to select “File”.
5. Press “Save” to enter the Save/Recall interface.
6. Choose the file you want then press “Load” (for five seconds).

Functional Description

STORAGE System (cont'd)

Save Picture

The waveform interface image can be saved to a USB flash drive, but can't be recalled. You can open these using adequate computer software.

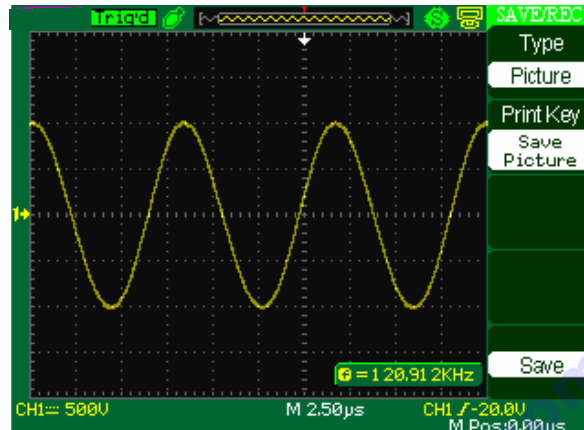

Option	Setting	Description
Type	Pictures	Menu for the Storage/Recall of waveform interface image.
Print Key	Print Picture	When the oscilloscope is connected to a printer and the "Back USB" option is set to "Printer", select "Print Picture" and press the "PRINT" button to print the screen image.
	Save Picture	When the USB flash drive is inserted in the USB Host interface (the USB flash drive open status icon will be displayed at the top of the screen), select "Save picture" and press the "Save" knob to enter the Save/Recall interface.
Save		Go to the Save/Recall interface.

Follow these steps

1. Select the screen image that you want.
2. Press "SAVE/RECALL" to enter "SAVE/RECALL" menu.
3. Press "Type" to select "Pictures".
4. Insert the USB flash drive.
5. Press the "Print Key" button to select "Save Picture".
6. Press "Save" then enter the Save/Recall interface.
7. Create the picture name then press the "Confirm" button.
8. Press "SAVE/RECALL" before removing the USB drive.

Functional Description

STORAGE System (cont'd)

Save / Recall Reference Waveform

The oscilloscopes can store two reference waveforms to non volatile memory.

The oscilloscope can display reference waveforms at a time.

Reference waveforms are not adjustable, but the oscilloscope displays the horizontal and vertical scales at the bottom of the screen.

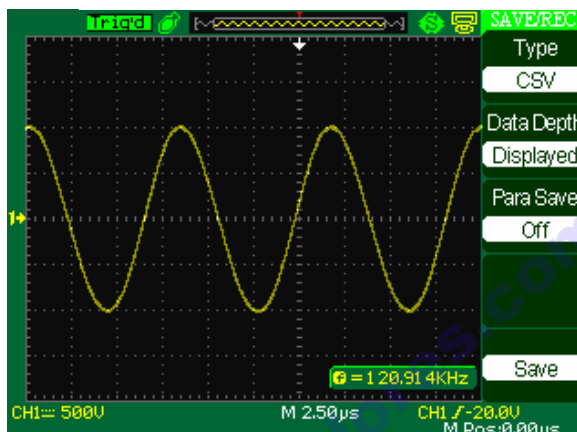

Option	Setting	Description
Type	CSV	Menu storing CSV files to a USB flash drive.
Data Depth	Displayed	Set to store displayed waveform data to CSV file.
	Maximum	Set to store maximum waveform data to CSV file.
Para Save	On	Set whether to store parameters to CSV file or not.
	Off	
Save		Enter the Save / Recall interface.

Follow these steps

1. Press the “SAVE/RECALL” button to enter “SAVE/RECALL” menu.
2. Press “Type” to select “CSV”.
3. Insert the USB flash drive.
4. Press “Data Depth” to select “Displayed” or “Maximum”.
5. Press “Para Save” to select “On” or “Off”.
6. Press “Save” then enter the Save/Recall interface
7. Create a file name then press “Confirm” (for about five seconds).
8. Press “SAVE/RECALL” before removing the USB drive.

Functional Description



UTILITY System (cont'd)

UTILITY System

Press the "UTILITY" button.

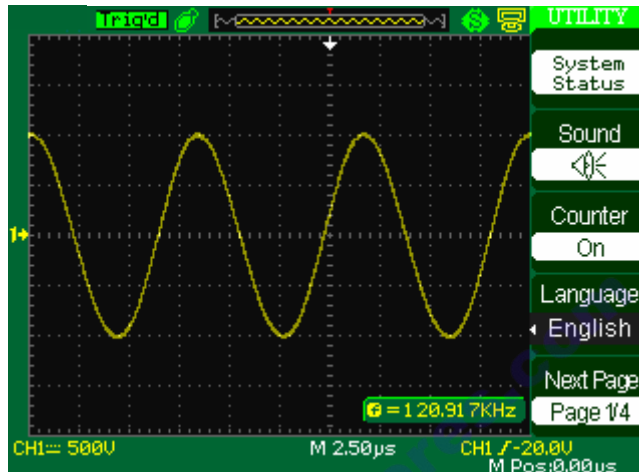
Utility System function menu 1



Option	Setting	Description
System Status		Displays a summary of the oscilloscope settings.
Sound	 	Open the key-press voice. Close the key-press voice.
Counter	On Off	Turn on Frequency Counter Turn off Frequency Counter.
Language	Simplified Chinese Traditional Chinese English Arabic French German Russian Spanish Portuguese Japanese Korean	Select interface language.

Functional Description

UTILITY System (cont'd)

Utility System function menu 2

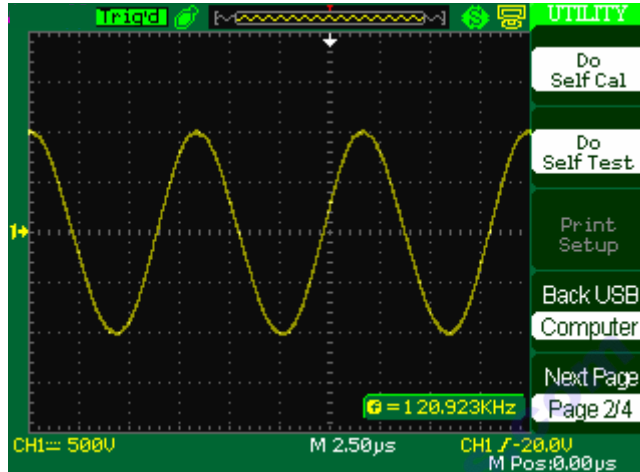

Option	Setting	Description
DO self Cal		Auto self calibration
Do Self Test	Screen Test	Run the screen detect program
	Keyboard Test	Run the keyboard detect program
	LED Test	Run the dot lighting detect program.
Print Setup		Enter the print setup menu to set print options.
Back USB	Printer	The oscilloscope is connected to the printer via a USB cable. When you execute print function, please select "Printer". The print icon will be displayed at the top of the screen.
	Computer	The oscilloscope is connected to the computer via a USB cable. When you execute the EasyScope software, select "Computer". The computer icon will be displayed on the screen.

Functional Description

UTILITY System

Utility System function menu 3

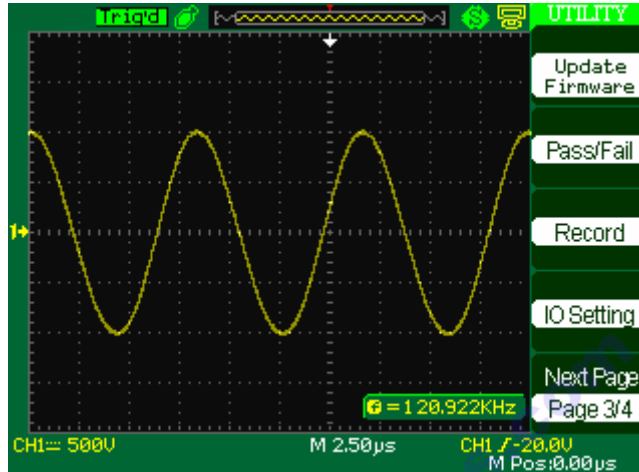

Option	Setting	Description
Update firmware		You can update the oscilloscope using a USB flash Driver.
Pass/Fail		Press this button to enter the "Pass/Fail menu".
Record		Press this button to enter the waveform record menu.
IO Setting		Press this button to enter the "IO Setting menu".

IO Setting function menu

Option	Setting	Description
Baud	300 2400 4800 9600 19200 38400	Set up band rate.

Functional Description

UTILITY System (cont'd)

Utility System function menu 4

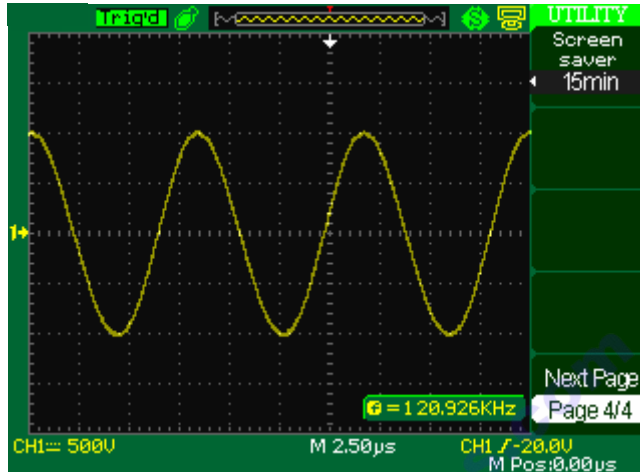

Option	Setting	Description
Screen-saver	1 min 2 min 5 min 10 min 15 min 30 min 1 hour 2 hours 5 hours off	Set the time for the screen-saver

Function checking

To check that oscilloscope is running smoothly, proceed as follows:

	<p>Set the switch to 1x on the probe and connect the probe to channel 1 on the oscilloscope. To do this, align the slot in the probe connector with the key on the CH 1 BNC, push to connect, and twist to the right to lock the probe in place. Connect the probe tip and reference lead to the PROBE COMP connectors.</p>
	<p>Press "AUTO" to show the 1KHz frequency and about 3V peak-peak square wave in couple seconds</p>
	<p>Press "CH1" twice times to cancel channel 1, Press "CH2" to change screen to channel 2, reset channel 2 as in steps 2 and 3.</p>

Functional Description

UTILITY System (cont'd)

System Status

Select "System Status" from the Utility Menu to display information pertaining to this oscilloscope.

Instructions

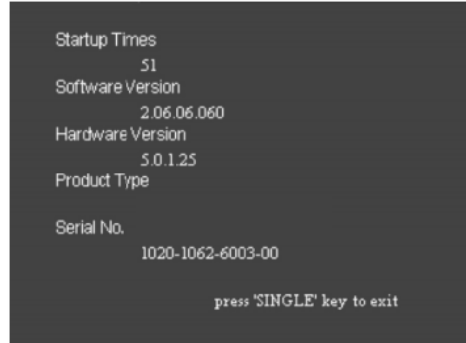

Print

You can connect a printer using a USB cable.

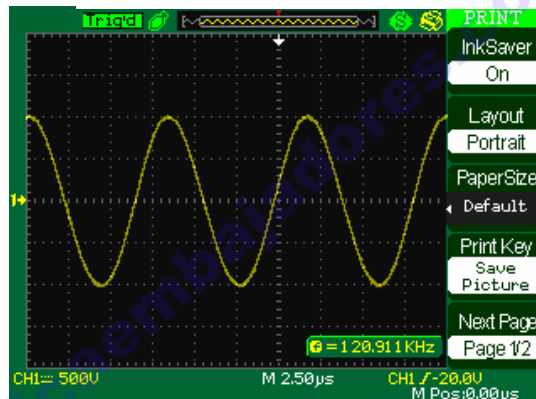

Print setup option function menu 1

Option	Setting	Description
Ink Saver	On Off	Prints the screen image on a white background when you select "on". Print the colour screen image when "off" is selected.
Layout	Portrait Landscape	Printer output layout.
Paper Size	Default, L, 2L, Hagaki Postcard, Card Size, 10 x 15 cm, 4" x 6", 8" x 10", Letter, 11" x 17", A0, A1, A2, A3, A4, A5, A6, A7, A8, A9, B0, B1, B2, B3, B4, B5, B6, B7, B8, B9, 89 mm, Roll (L), 127 mm Roll (2L), 100 mm Roll (4"), 210 mm Roll(A4)	Displays Settings available on your PictBridge compatible printer.
Print Key	Print Key Print Picture	Select "Print Picture" option when the oscilloscope is connected to a printer, press "S/div" to print the picture. Select "Save Picture" option when a USB drive is inserted, press the "S/div" knob to save the picture.

Functional Description

UTILITY System (cont'd)

*Print setup option
function menu 2*

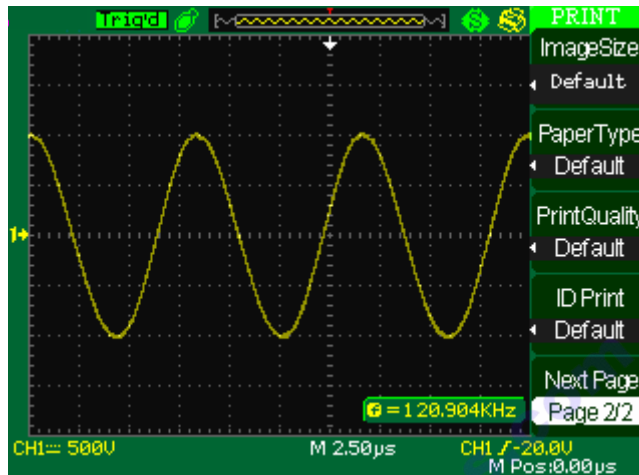

Option	Setting	Description
Image Size	Default, 2.5x3.25 in, L (3.5x5 in), 4x6 in, 2L (5x7 in), 8x10 in, 4L (7 x 10 in), E, Card, Hagaki card, 6 x 8 cm, 7x10 cm, 9x13 cm, 10x15 cm, 13x18 cm, 15x21 cm, 18x24 cm, A4, Letter	Displays Settings available on your PictBridge compatible printer.
Paper Type	Default, plain, Photo, Fast Photo	
Print Quality	Default, Normal, Draft, Fine	
ID Print	Default, On, Off	

Note

The oscilloscope is designed to print to any PictBridge compatible printer. Refer to product documentation for your printer to determine if your printer is PictBridge compatible.

Power on the oscilloscope, connect the oscilloscope to the printer with the USB cable, the power on the printer.

Functional Description

UTILITY System (cont'd)

Update Firmware

The software can be updated directly using a USB Flash drive.

Follow next steps

1. Insert the USB Flash Drive with firmware.
2. Press the "UTILITY" button.
3. Press "Next Page" to enter the third page of the "Utility menu".
4. Press the "Update Firmware" option button.
5. Press the "SINGLE" button to start updating the software.
6. Turn off the oscilloscope and turn on it again, the software has been updated. The oscilloscope will execute a "Do Self Cal" after updating.

www.electronicaembajadores.com

Functional Description

UTILITY System (cont'd)

Pass / Fail

The Pass/Fail function can monitor changes in signals and output pass or fail signals by testing whether the input signal is within the predefined mask or not.

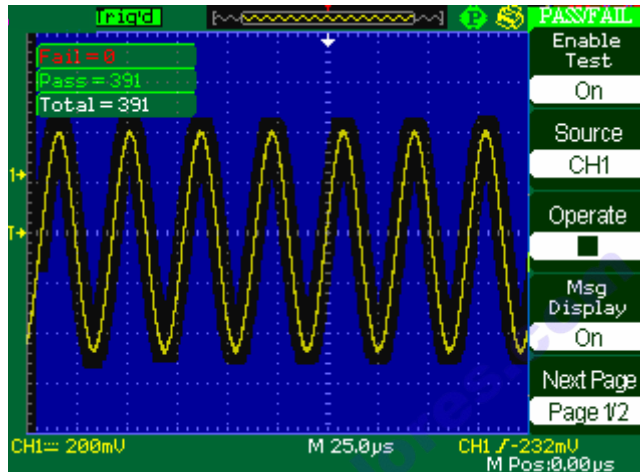

Pass/Fail function menu 1

Option	Setting	Description
Enable	On	Turn on Pass/Fail function.
	Off	Turn off Pass/Fail function.
Source	CH1	Select Pass/Fail test on CH1.
	CH2	Select Pass/Fail test on CH2.
Operate	▶	Press to run the Pass/Fail test.
	■	Press to stop the Pass/Fail test.
Msg Display	On	Turn on time information display for the waveform pass/fail.
	Off	Turn off time information display for the waveform pass/fail.

Functional Description

UTILITY System (cont'd)

Pass / Fail function menu 2

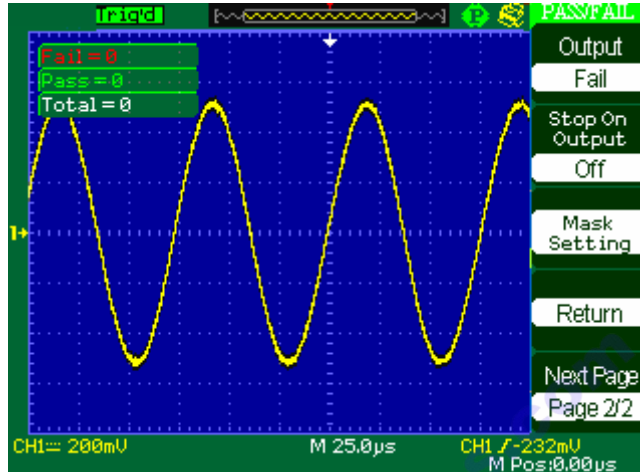

Option	Setting	Description
Output	Pass	Output when pass condition detected.
	Fail	Output when fail condition detected.
Stop On Output	On	Stop test on output
	Off	Continue test on output.
Mask Setting		Press this button to enter the "Mask Setting menu".
Return		Return to the Pass/Fail main menu.

Functional Description

UTILITY System (cont'd)

Mask Setting

*Mask Setting
function menu 1*

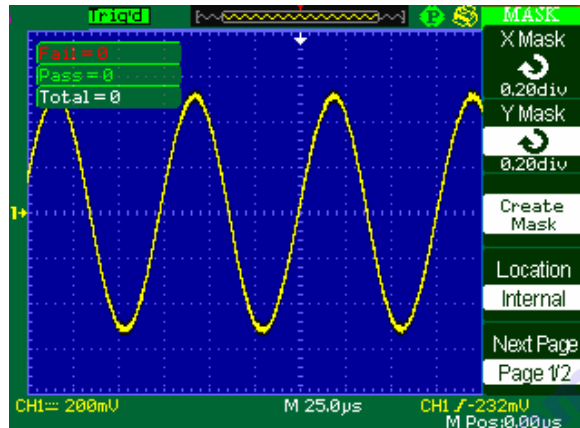

Option	Setting	Description
X Mask ↻ xdiv		Turn the “Universal” knob to set the range of horizontal clearance to the waveform. <0.04div-4.00div>
Y Mask ↻ ydiv		Turn the “Universal” knob to set the range of vertical clearance to the waveform. <0.04div-4.00div>
Create Mask		Create a test mask according to the above clearance data.
Location	Internal External	Select where to store created mask.

*Mask Setting
function menu 2*

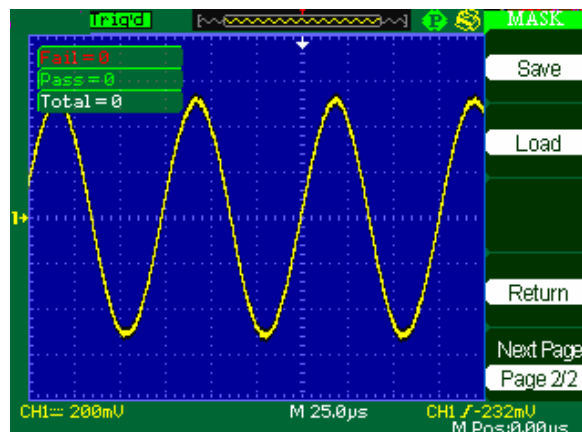

Option	Setting	Description
Save		Store created mask setting.
Load		Recall stored mask setting.
Return		Return to the main menu of mask setting.

Functional Description

UTILITY System (cont'd)

RUN Pass/Fail test

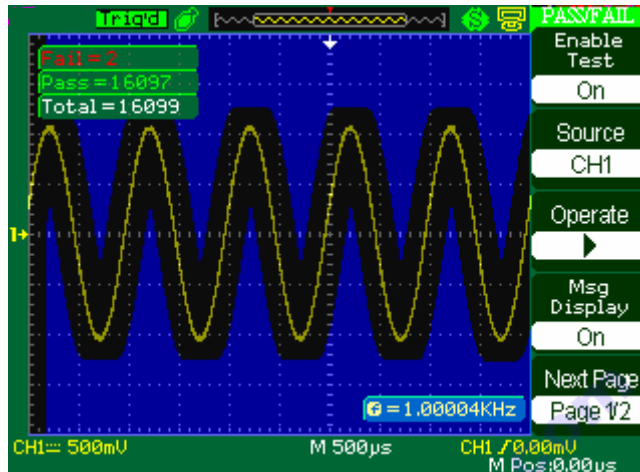

Follow next steps

1. Press UTILITY button to enter the “Utility menu”.
2. Press “Next Page ” to enter the third page of “Utility menu”
3. Press “Pass/Fail” to enter the “Pass/Fail” function menu.
4. Press “Enable Test” to select “Open”.
5. Press “Source” to select input signal channel.
6. Press “Next Page” to enter the second page of the “Pass/Fail menu”.
7. Press the “Mask Setting” button to enter the first page of “Mask menu”.
8. Press “X Mask”, turn the “Universal” knob to adjust the horizontal clearance.
9. Press “Y Mask”, turn the “Universal” knob to adjust the vertical clearance.
10. Press “Create Mask” to create mask and you can also can the next page of “Mask menu” to recall the stored mask.
11. Enter the second page of “Pass/Fail function menu”, press “Output” to set the output option.
12. Enter the first page of the “Pass/Fail function menu”, press “Operate” to select “▶” and to run the pass/fail test.

Note

The output signal is 3 V. When an error is detected, the output signal is 0 V during 125 µs.

Functional Description

UTILITY System (cont'd)

Waveform Record

The waveform recorder can record input waveform from CH1 and CH2, with a maximum record length of 2500 frames.

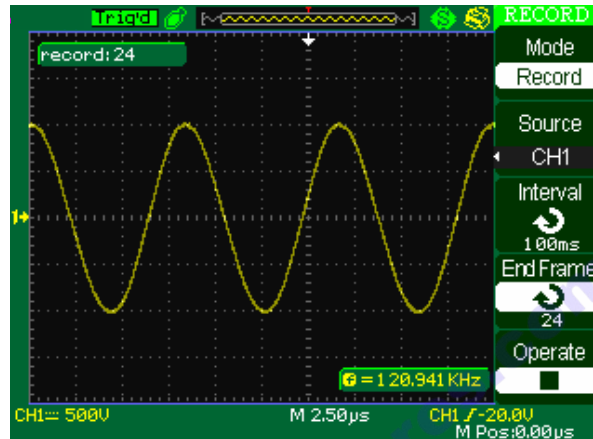

Waveform recorder function menu

Option	Setting	Description
Mode	Record	Set Record function menu.
	Play Back	Set Play Back function menu.
	Off	Turn off waveform recorder menu.
Source	CH1 CH2 P/F-OUT	Select record source channel.
Interval	↻	Set time interval between record frames. turn the “Universal” knob to adjust time interval between recorded frames.
End Frame	↻	Set max number of recorded frames. select the “Universal” knob to adjust the max recorded frame.
Operate	● (Record)	Press to start recording.
	■ (Stop)	Press to stop recording.

Functional Description

UTILITY System (cont'd)

Play Back

Play back current record waveforms or saved record waveforms.

*Waveform play
back function
menu 1*

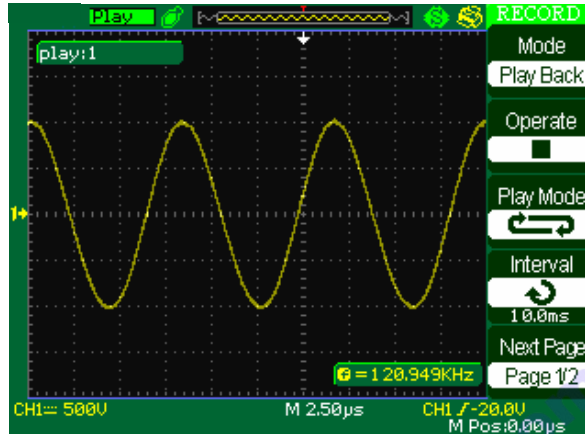

Option	Setting	Description
Mode	Play Back	Set the Play Back function menu.
Operate	▶ □ Run □ ■ □ Stop □	Press to start playback playing. Press to stop playing.
Play Mode	↻ ▶ □	Set loop play mode. Set single time play mode.
Interval	↻	Set time interval between frames.

*Waveform play
back function
menu 2*

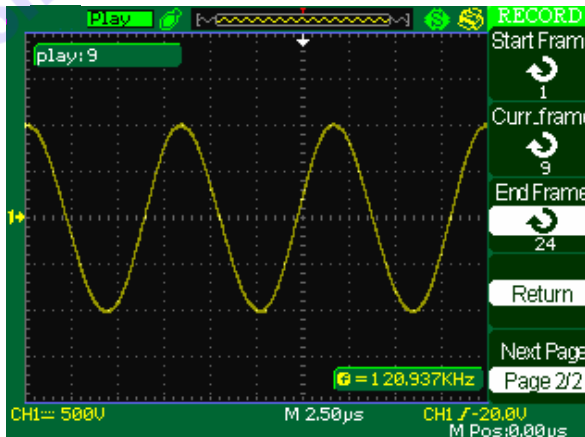

Option	Setting	Description
Start Frame	↻	Set start frame.
Curr_Frame	↻	Select current frame to be played.
End Frame	↻	Set End frame.
Return		Press to return the waveform recorder main menu.

Functional Description

UTILITY System (cont'd)

Recorder

The waveform recorder is a type of seamless and no-gap real time recording of waveform. This means that oscilloscope can save and replay the waveforms it captured. This is similar to a waveform recording instrument, and the largest recording size for its internal memory is 6M

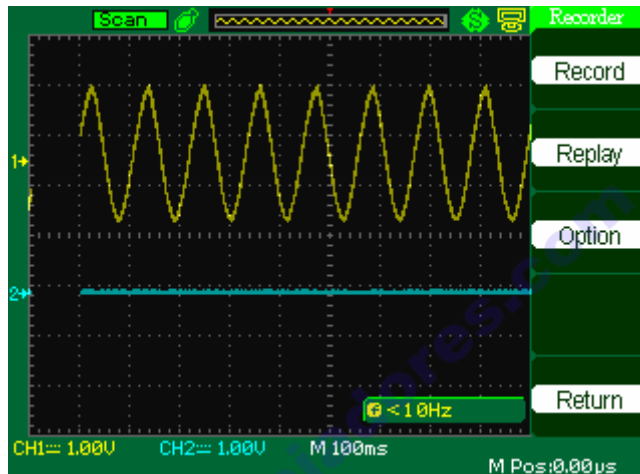

Waveform recording function menu

Option	Description
Record	Record the waveform persistently
Replay	Replay recorded waveform.
Option	Set the recorder properly.
Return	Quit the recording function

Functional Description

UTILITY System (cont'd)

Waveform recalling function menu

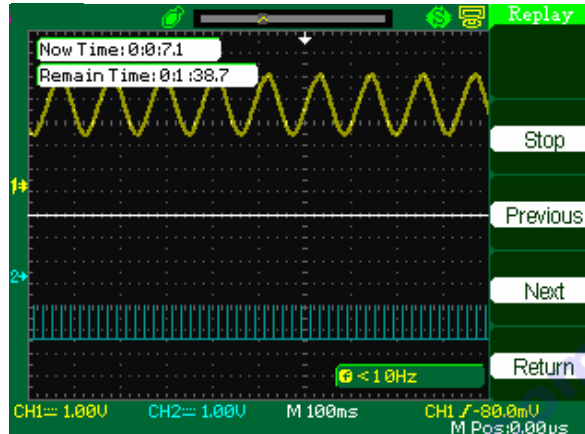

Option	Description
Stop	Quit the auto-recalled waveform, the waveform in EMS memory can then be observed by changing the time base, the waveform in EMS memory can be moved left and right
Previous	Recalls previous waveform
Next	Plays the next recalled waveform
Return	Quit the recall interface

Functional Description

UTILITY System (cont'd)

Recorder setting menu

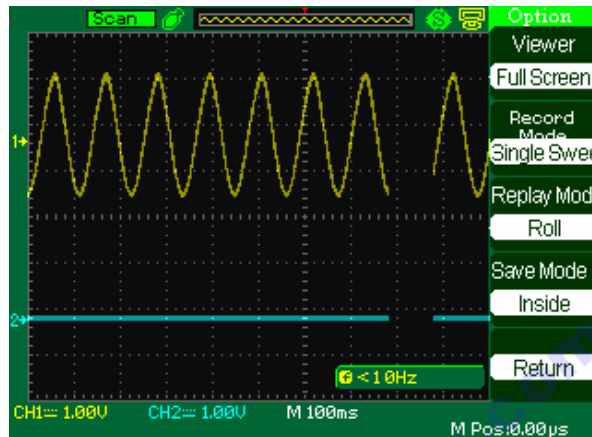

Option	Setting	Description
Viewer	Full Screen	Waveform full screen recording and channel recalling
	Split	Waveform recording on split screen and channel recalling. CH1 is displayed in the upper half-screen, CH2 is displayed in lower half-screen.
Record Mode	Roll	The recorder saves the channel waveform continuously, the latter waveform will cover the former.
	Single Sweep	The recorder will stop saving when its memory reaches 6M.
Replay Mode	One by One	when recalling, the screen waveform will refresh from left to right
	Roll	When recalling, screen waveform will refresh completely according to the capturing time of each frame
Return		Quit the recording setting interface

Nota Recorder can only be used in scan mode. To display scan mode, see p. 21.

Technical specifications

Inputs		
<i>Input coupling</i>	AC, DC, GND	
<i>Input impedance</i>	1 M Ω \pm 2 % (\parallel 17 pF \pm 3 pF)	
<i>Max. input voltage</i>	400 V (DC + ACp)	
<i>Probe attenuator</i>	x 1, x 10	
<i>Probe attenuator factors</i>	x 1, x 5, x10, x 50, x 100, x 500, x 1000	
<i>Averaging</i>	4, 16, 32, 64, 128, 256	
Output Pass / Fail		
<i>Output Pulse</i>	3 V	
<i>Protection</i>	40 V	
Signal	XDO2025	XDO2040
<i>Sample types</i>	Real time, equivalent time	
<i>Memory depth</i>	16 kpts each channel	normal : 20 kpts each channel long memory : 2 Mpts for one-channel mode 1 Mpts for two-channel mode
<i>Peak measure</i>	With a low speed signal (from 10 μ s/div. start), it is possible to capture high-frequency burr which are narrow to 10 ns.	
<i>Sampling mode</i>	Sample, peak measure, average	
Vertical	XDO2025	XDO2040
<i>Sensitivity</i>	from 2 mV/div. to 10 V/div. (by step of 1 - 2 - 5)	
<i>Channels</i>	CH1 and CH2	
<i>Résolution</i>	8 bits	
<i>Bandwidth</i>	0 to 25 MHz	0 to 40 MHz
<i>Lower frequency limit (AC -3 dB)</i>	\leq 10 Hz (at BNC input)	
<i>DC measurement accuracy</i>	Settings : gain < 100 mV/div. \pm [3 % x (reading + offset) + 1 % of offset + 0.2 div. + 2 mV]	
<i>DC gain accuracy</i>	\leq \pm 3 % : from 5 mV/div. to 10 V/div. with fixed gain ranges \leq \pm 4 % : typical for 2 mV/div. with variable gain ranges	
<i>Rising time</i>	< 14 ns	< 8,8 ns
<i>Input coupling</i>	AC - DC - GND	
<i>MATH</i>	+, -, *, /, FFT	
<i>FFT</i>	Hanning, Hamming, Blackmann, rectangular	
<i>BW limit</i>	-	20 MHz (-3 dB)

Technical specifications (cont'd)

Horizontal	XDO2025	XDO2040
Max. sampling rate (singleshot)	250 MS/s (2-channel) 500 MS/s (1-channel)	500 MS/s (2-channel) 1 GS/s (1-channel)
Equivalent sampling	10 GS/s	25 GS/s
Measure display modes	main, window, zoom, z window zoom, roll, X-Y	
Accuracy	± 0.01 %	
Ranges	from 25 ns/div. to 50 s/div. (25 MHz bandwidth)	from 10 ns/div. to 50 s/div. (40 MHz bandwidth)
Trigger		
Type	Edge, pulse width, video, slope, alternative	
Modes	Auto, normal, single	
Coupling	AC, DC, low frequency reject, high frequency reject	
Level	CH1, CH2 : ± 6 div. from the middle of the screen EXT : ± 1,2 V EXT / 5 : ± 6 V	
Trigger Delay	Pretrig : 12 div., trigger delay : 130 div.	
Holdoff	Range : 100 ns - 1,5 s	
Edge	Rising, falling, rising/falling	
Pulse width	mode : >, <, = : positive pulse width >, <, = : negative pulse width	
	range : 20 ns - 10 s	
Video	PAL/SECAM ; NTSC	
	conditions : odd field, even field, all lines, line num	
Slope	>, <, = : positive slope >, <, = : negative slope	
	range: 20 ns - 10 s	
Alternative Trigger	CH1 : edge, pulse, video, slope CH2 : edge, pulse, video, slope	

Technical specifications (cont'd)

X-Y Mode	
<i>X axis</i>	CH1 input (CH1)
<i>Y axis</i>	CH2 input (CH2)
<i>X-Y dephasing</i>	$\leq 3^\circ$ DC at 50 kHz

Measurement types	
<i>Auto measurements</i>	Vcc, Vmax, Vmin, Vamp, Vtop, Vbase, Vavg, Mean, Crms, Vrms, ROVShoot, FOVShoot, RPRESshoot, FPRESshoot, rise time, fall time, frequency, period + Wid., - Wid ., +Dut, -Dut, BWid, Phase, FRR, FRF, FFR, FFF, LRR, LRF, LFR, LFF
<i>Cursor measurements</i>	manual, auto, track

Display settings	
<i>Autoset</i>	Auto setting of the vertical, horizontal and trigger position
<i>Save/Recall</i>	Refer to page

Hardware Frequency Counter	
<i>Resolution</i>	6 bits
<i>Range</i>	DC couple, 10 Hz at max. bandwidth.
<i>Signal types</i>	satisfying all the trigger signals (except pulse, width and trigger video)

General specifications

Environmental

- Operating temperature 10°C to 40°C
- Storage temperature - 20°C to + 60°C
- Use indoors
- Altitude < 3000 m
- Relative humidity 95 %, 40°C, 24 h

Power supply

- Mains voltage 10 - 240 VAC
- Frequency 45 to 440 Hz
- Consumption 50 VA max
- Fuses 1.25 A / 250 V
- Removable power cord

Safety

- As per EN 61010-1 : 2001
- Isolation class 1
- Pollution degree 2
- Power supply overvoltage category 240 V

CE

EMC

- As per EN 61326-1 : 2006

Mechanical features

Casing

- Dimensions XDO2025 305 x 133 x 154 mm
XDO2040 339 x 111 x 149 mm
- Weight 2.4 kg approx.

Screen

- XDO2025 Colour TFT 5.7 inches 320 x 234 pixels
- XDO2040 Colour TFT 7 inches 480 x 234 pixels

Supply

Accessories

delivered with the instrument

- 2 probes 60 MHz (1x ; 10 x)
- USB cable
- Power cable
- CD including user's manual and Easy Scope Computer Software with instrument drivers