

General Warranty

OWON warrants that the product will be free from defects in materials and workmanship for a period of 3 years (1 year for accessories) from the date of purchase of the product by the original purchaser from the OWON Company. This warranty only applies to the original purchaser and is not transferable to the third party.

If the product proves defective during the warranty period, OWON either will repair the defective product without charge for parts and labor, or will provide a replacement in exchange for the defective product. Parts, modules and replacement products used by OWON for warranty work may be new or reconditioned like new performance. All replaced parts, modules and products become the property of OWON.

In order to obtain service under this warranty, customer must notify OWON of the defect before the expiration of the warranty period. Customer shall be responsible for packaging and shipping the defective product to the service center designated by OWON, and with a copy of customer proof of purchase.

This warranty shall not apply to any defect, failure or damage caused by improper use or improper or inadequate maintenance and care. OWON shall not be obligated to furnish service under this warranty a) to repair damage resulting from attempts by personnel other than OWON representatives to install, repair or service the product; b) to repair damage resulting from improper use or connection to incompatible equipment; c) to repair any damage or malfunction caused by the use of non-OWON supplies; or d) to service a product that has been modified or integrated with other products when the effect of such modification or integration increases the time or difficulty of servicing the product.

Please contact the nearest OWON's Sales and Service Offices for services.

For better after-sales service, please visit www.owon.com.cn and register the purchased product online.

Excepting the after-sales services provided in this summary or the applicable warranty statements, OWON will not offer any guarantee for maintenance definitely declared or hinted, including but not limited to the implied guarantee for marketability and special-purpose acceptability. OWON should not take any responsibilities for any indirect, special or consequent damages.

For more details, please refer to the user manual on the supplied CD, it can also be downloaded at www.owon.com.cn.

Table of Contents

1.General Safety Requirement	1
2.Safety Terms and Symbols.....	2
3.General Inspection.....	3
4.Quick Start	4
Front panel overview	4
Rear Panel Overview	6
Power on	7
User Interface.....	8
Use build-in Help.....	9
Set the channel	9
Set basic waveform	9
Output the build-in waveform (including DC)	11
Edit the arbitrary waveform.....	11
Generate the Modulated Waveform	12
Generate Sweep.....	13
Generate Burst	13
Counter.....	14
File Store System.....	15
Save the current arbitrary wave.....	15
Bring up arbitrary wave files in internal/external memory	16
Erase waveforms from memory.....	16
Save/recall instrument setup.....	17
Utility Setting.....	17
5.Communicate with PC.....	19
Using USB Port	19
Using LAN Port	19
Connect Directly.....	19
Connect through a Router	20
6.Appendix.....	22
Appendix A: Accessories	22
Appendix B: General Care and Cleaning.....	22

1. General Safety Requirement

Before any operations, please read the following safety precautions to avoid any possible bodily injury and prevent this product or any other products connected from damage. In order to avoid any contingent danger, this product is only used within the range specified.

Use Proper Power Cord. Use only the power cord supplied with the product and certified to use in your country.

Product Grounded. This instrument is grounded through the power cord grounding conductor. To avoid electric shock, the grounding conductor must be grounded. The product must be grounded properly before any connection with its input or output terminal.

Limit operation to the specified measurement category, voltage, or amperage ratings.

Check all Terminal Ratings. To avoid instrument damage and the risk of electric shock, check all the Measurement Limits and markers of this product. Refer to the user's manual for the Measurement Limits before connecting to the instrument. Do not exceed any of the Measurement Limits defined in the following section.

Do not operate without covers. Do not operate the instrument with covers or panels removed.

Use Proper Fuse. Use only the specified type and rating fuse for this instrument.

Avoid exposed circuit. Do not touch exposed junctions and components when the instrument is powered.

Do not operate if in any doubt. If you suspect damage occurs to the instrument, have it inspected by qualified service personnel before further operations.

Use your instrument in a well-ventilated area. Inadequate ventilation may cause increasing of temperature or damages to the device. Please keep well ventilated and inspect the intake regularly.

Do not operate in wet conditions. In order to avoid short circuiting to the interior of the device or electric shock, please do not operate in a humid environment.

Do not operate in an explosive atmosphere.

Keep product surfaces clean and dry.

Only the qualified technicians can implement the maintenance.

2. Safety Terms and Symbols

Terms in this Manual. The following terms may appear in this manual:

Warning: Warning indicates the conditions or practices that could result in injury or loss of life.

Caution: Caution indicates the conditions or practices that could result in damage to this product or other property.

Terms on the Product. The following terms may appear on this product:

Danger: It indicates an injury or hazard may immediately happen.

Warning: It indicates an injury or hazard may be accessible potentially.

Caution: It indicates a potential damage to the instrument or other property might occur.

Safety Symbols

Symbols on the Product. The following symbol may appear on the product:



Hazardous Voltage



Refer to Manual



Protective Earth Terminal



Chassis Ground



Test Ground

3. General Inspection

After you get a new multimeter, it is recommended that you should make a check on the instrument according to the following steps:

1. Check whether there is any damage caused by transportation.

If it is found that the packaging carton or the foamed plastic protection cushion has suffered serious damage, do not throw it away first till the complete device and its accessories succeed in the electrical and mechanical property tests.

2. Check the Accessories

The supplied accessories have been already described in the Appendix A: Enclosure of this Manual. You can check whether there is any loss of accessories with reference to this description. If it is found that there is any accessory lost or damaged, please get in touch with the distributor of OWON responsible for this service or the OWON's local offices.

3. Check the Complete Instrument

If it is found that there is damage to the appearance of the instrument, or the instrument can not work normally, or fails in the performance test, please get in touch with the OWON's distributor responsible for this business or the OWON's local offices. If there is damage to the instrument caused by the transportation, please keep the package. With the transportation department or the OWON's distributor responsible for this business informed about it, a repairing or replacement of the instrument will be arranged by the OWON.

4. Quick Start

Front panel overview

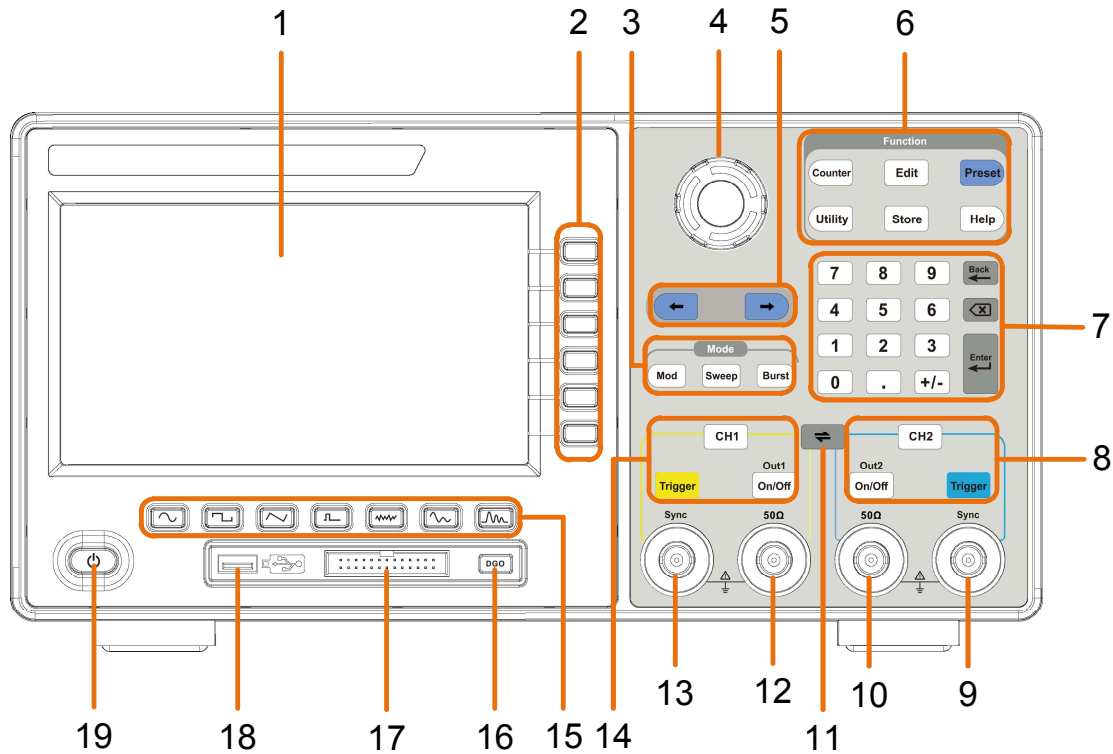









Figure 4-1 Front Panel overview

1	LCD	Display the user interface
2	Menu selection keys	Includes 6 keys to activate the corresponding menu
3	Mode keys	<p>Mod: output the modulated waveform</p> <p>Sweep: scan the sine, square, ramp or arbitrary waveforms</p> <p>Burst: generate the sine, square, ramp, pulse or arbitrary burst</p>
4	Knob	<p>Change the currently selected value, also used to select the character in the soft keyboard when the file location or file name is entered.</p> <p>When inserting a USB flash drive, press the knob to save the current display screen to the folder of the USB flash drive in BMP image format.</p>
5	Direction key	Move the cursor of the selected parameter

6 Operation keys	<p>Counter: enter the counter interface</p> <hr/> <p>Edit: enter the waveform edit interface</p> <hr/> <p>Preset: enter the preset menu, set the reset parameter or power-on parameter; save or load the setting file.</p> <hr/> <p>Utility: set the utility function</p> <hr/> <p>Store: save/load arbitrary waveform or instrument setup</p> <hr/> <p>Help: To get contextual help for any front panel button or menu softkey, press the button and then press the button for which you need help.</p>
7 Number keypad	Input the parameter
8 CH2 Function keys	<p>CH2 button: After entering the waveform interface and selecting the CH2 channel (the backlight of the button is on), the waveform and parameters of CH2 can be set after selection.</p> <hr/> <p>Blue Trigger button: CH2 manual trigger button. In sweep or burst mode, when the trigger source is selected as “Manual”, each press of this button will initiate a trigger.</p> <hr/> <p>On/Off button: Turns the output of the CH2 channel on or off. When the output is turned on, the backlight of the button lights up.</p>
9 CH2 Sync	When Utility → CH1/2 Set → CH2 Sync turned on, this terminal outputs a synchronization message that matches the current configuration of CH2.
10 CH2 Out	Output CH2 signal
11 CH1⇌CH2 button	Display the channel copy menu
12 CH1 Out	Output CH1 signal
13 CH1 Sync	When Utility → CH1/2 Set → CH1 Sync turned on, this terminal outputs a synchronization message that matches the current configuration of CH1.
14 CH1 Function keys	<p>CH1 button: After entering the waveform interface and selecting the CH1 channel (the backlight of the button is on), the waveform and parameters of CH1 can be set after selection.</p>

Yellow Trigger button: CH1 manual trigger button. In sweep or burst mode, when the trigger source is selected as “Manual”, each press of this button will initiate a trigger.

On/Off button: Turns the output of the CH1 channel on or off. When the output is turned on, the backlight of the button lights up.

15 Waveform Selection area	Includes: Sine  , Square  , Ramp  , Pulse  , Noise  , Arb Wave  , Harmonic Wave  . When a waveform is selected, the corresponding backlight is lit.
16 DGO button	Digital output (only for the model with digital output function)
17 Digital channel	Digital signal Output connector (only for the model with digital output function)
18 USB interface	Connect with external USB devices, e.g. U disk.
19 Power button	Turn on/off the waveform generator.

Rear Panel Overview

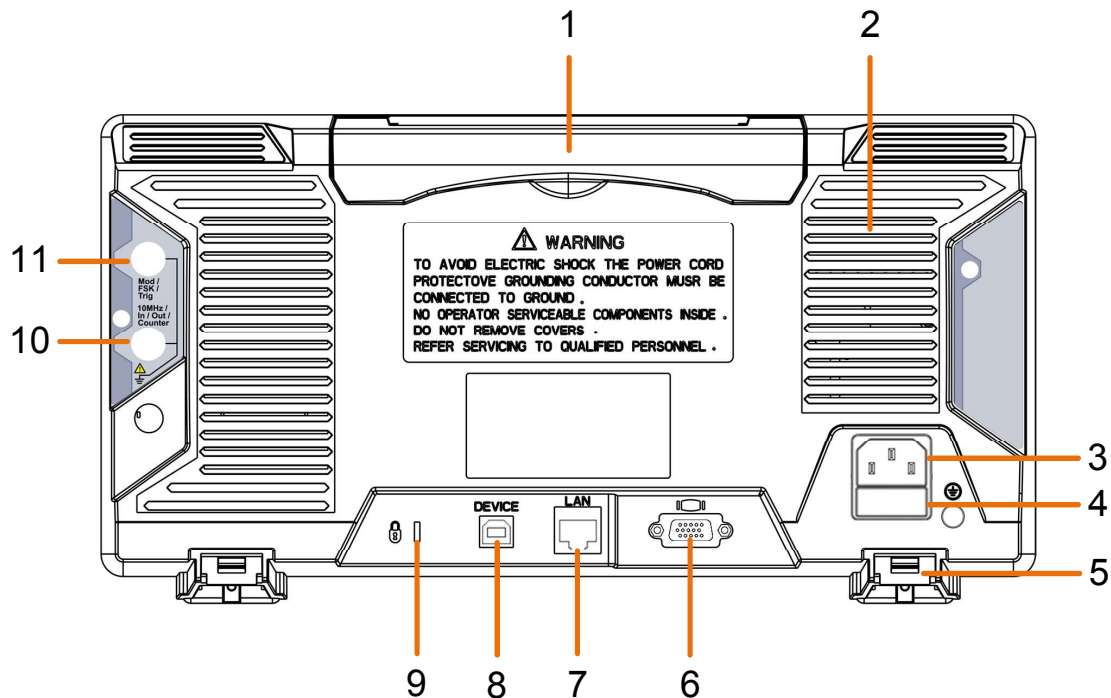

Figure 4-2 Rear Panel Overview

1 Retractable handle

2	Air vents	
3	AC input connector	AC input connector
4	Fuse Container	The place to install the fuse
5	Foot Stool	Tilt the signal generator for easy operation.
6	COM interface (optional)	This interface can be used to connect with PC.
7	LAN interface	The network port which can be used to connect with PC.
8	USB Device interface	Used to connect a USB type B controller. Can be connected with PC, the signal generator can be controlled by the host computer software.
9	Lock Hole	You can lock the device to a fixed location using the security lock (please buy it yourself) to secure the device.
10	10MHz/In/Out/Counter (refer to clock input/output/counter input) connector	It is default to receive the frequency meter input signal. Used to receive a 10MHz clock signal when the instrument is set to an internal clock source and Utility → System → CLK Output is turned on; it is used to receive an external 10MHz clock signal when the instrument is set to an external clock source.
11	Mod/FSK/Trig (modulation/trigger input) connector	<p>When modulating the waveform, outputting the sweep frequency, and outputting the burst, the signal accessed here can be used as an external source.</p> <p>Note: If one channel turns on AM, FM, PM, PWM or OSK, and the other channel turns on ASK, FSK, PSK, sweep or burst, and both channels are set to external trigger, then the channel that sets the trigger source can be accessed to external trigger, the other channel automatically cancels the external trigger because of the different external modulation signal types.</p>

Power on

- (1) Connect the instrument to an AC power source using the power cord supplied with the accessory.



Warning:

To prevent electric shock, make sure the instrument is properly grounded.

(2) Press the **power button** on the front panel. The startup screen will display.

User Interface

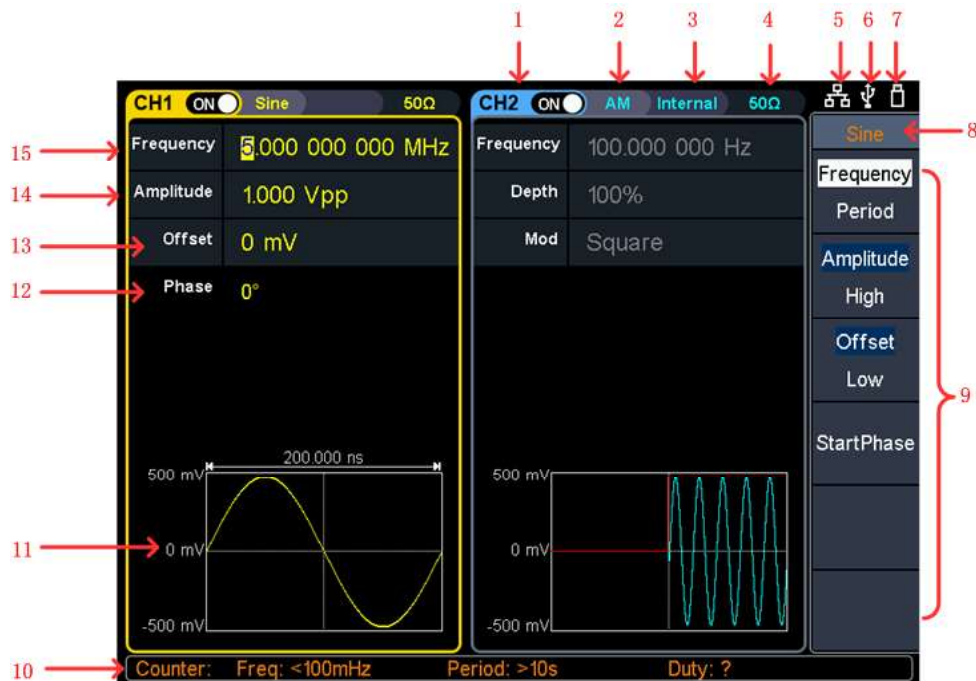

Figure 4-3 User Interface

1	Display channel name and channel switch status
2	Current waveform or current mode
3	Trigger source Internal: Internal modulation or internal trigger source External: External modulation or external trigger source Manual: Manual trigger source
4	Load, High Z indicates high resistance
5	This indicator is lit when the network is connected through the LAN interface.
6	Lights up the indicator when connected to the USB Host via the USB DEVICE interface.
7	When the instrument detects the USB flash drive, it lights up the indicator.

8	Current menu name
9	Current waveform or mode setting menu
10	Counter brief information showing frequency value, period value
11	Display current waveform
12	Start phase
13	Offset / low level, depending on the right highlighted menu item
14	Amplitude / high level, depending on the right highlighted menu
15	Frequency/cycle, depending on the highlighted menu item on the right

Use build-in Help

- (1) To get help on any front panel button or menu softkey, first press the front panel **Help** function button, then press the button you need help with.
- (2) Press the **Help** function key again to exit the help interface.

Set the channel

- **Select the channel for configuration**

Before configuring waveform parameters, you must first select the channel you want to configure. Press **CH1** or **CH2** to select the corresponding channel, and the corresponding channel area in the user interface will light up.







- **Turn on/off channel output**

Press CH1 **On/Off** or CH2 **On/Off** on the front panel to turn on/off the corresponding channel output. The channel will light up when it is set to output.

- **Channel copy**

- (1) Press the front panel **CH1⇌CH2** button to display the channel copy menu.
- (2) Select **CH2 To _CH1** or **CH1 To _CH2** to copy the channel.

Set basic waveform

Can set and output the Sine, Square, Ramp, Pulse, Noise, Arbitrary or Harmonic waveform. Press the waveform selection button on the front panel of the instrument: sine , square , ramp , pulse , noise , arbitrary , harmonic , and enter the corresponding waveform setting

interface. The waveform is different and the parameters that can be set are different.

Example: Press the  key and press the **Frequency/Period** soft key. The selected menu item is highlighted on white, and the cursor will display on corresponding parameter item in the user interface. Press the **Frequency/Period** softkey to switch the frequency/period.

There are two ways to change the selected parameter value:

- Turn the **Knob** to increase or decrease the value at the cursor. Press the arrow keys to move the cursor left or right.
- Press a **number key** on the numeric keypad directly, the screen will pop out of the data input box, continue to input the desired value. Press the  key to delete the last digit. Press the right menu soft key to select the unit of the parameter. Press the **Cancel** softkey to cancel the current entry.

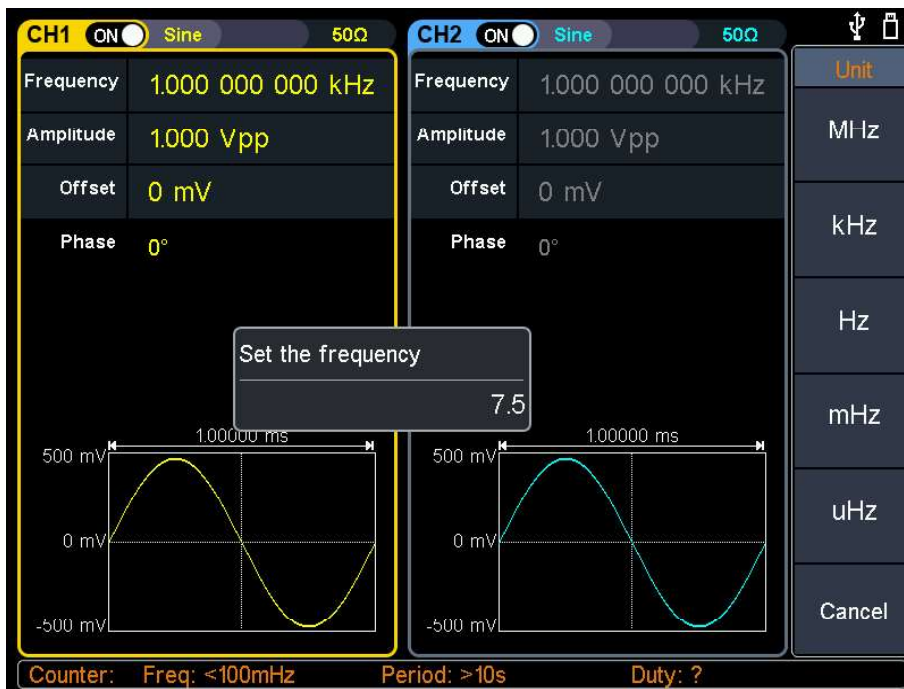



Figure 4-4: Use numeric keypad to set the frequency

Parameters of waveforms

Waveform	Menu Items
Sine	Frequency/Period, Amplitude/High, Offset/Low, StartPhase
Square	Frequency/Period, Amplitude/High, Offset/Low, StartPhase
Ramp	Frequency/Period, Amplitude/High, Offset/Low, StartPhase, Symmetry
Pulse	Frequency/Period, Amplitude/High, Offset/Low, StartPhase,

	Width/DutyCyc, Rising/Falling
Noise	Amplitude/High, Offset/Low
Arbitrary	Frequency/Period, Amplitude/High, Offset/Low, StartPhase, Bult-in
Harmonic	Frequency/Period, Amplitude/High, Offset/Low, StartPhase, Type, Order, SN, Amplitude, Phase

Output the build-in waveform (including DC)

- (1) Press the  arbitrary wave button to enter the arbitrary wave menu and configure the waveform parameters.
- (2) Press the **Built-in** softkey, the build-in waveform type menu will show.
- (3) Press the **Common**, **Medical treatment**, **Standard**, **Maths**, **Trigonometric**, **Window function**, **Engineering**, **Seg Mod** softkeys to enter a detailed list of categories.
- (4) Rotate the **knob** and select the file in the list, and press the **OK** softkey.

Note: DC is a type of built-in waveform, located in the "Common" category, named "DC".

Edit the arbitrary waveform

Press the **Edit** on front panel to enter the arbitrary edit interface.

- (1) **Set the wave points:** Press the **Points** softkey, turn the **knob** to adjust the value, or use the numeric keypad and press unit softkey. Range between 2 to 100,000.
- (2) **Select the template:**
 Press the **Basic Template** softkey to select Blank, Sine wave, Square wave, Ramp wave, and Noise.
 Press the **Arb Template** softkey to select a built-in waveform as template.
- (3) **Edit the wave points:** Press **Edit Points** to enter the wave points menu.
 - Select **Points**, input the number of point to be edited.
 - Select **Voltage**, input the voltage of the point.
 - Repeat this step to set all the points.
 - Press **Write** to enter the file system interface.

If you want to save the waveform to the internal memory, select INTER and press **Enter** softkey. Turn the knob to select one of the USER files (EditMemory cannot be selected) and press the **Save** softkey. (The file size is displayed on the right side of the USER file. If 0B is displayed, it

means the file is empty.)

Description: EditMemory is a temporary data space created, saved, edited or recalled by any arbitrary wave. Saving the waveform is to save the data of this space to the user-specified location (EditMemory is in the memory and never empty). The data in this space is changed after an arbitrary waveform is called, a new waveform is created, or a related programming command is received.

- If you want to save to a USB storage device, you need to plug the USB storage device into the front panel USB port. Turn the knob to select USBDEVICE. Press the **Enter** softkey and the instrument will list the directories of the folders and files in the USB storage device. You can turn the knob to select a folder or file. Press the **Enter** softkey to enter the currently selected folder. To return to the parent directory, press the **Back** softkey. After selecting the storage path, press the **SaveAs** softkey and the input keyboard appears on the screen. Turn the knob to select a character. Press the **ABC/abc** softkey to toggle the case of keyboard characters. Press the **Select** softkey to enter the current character. Press the **Delete** softkey to delete the last character that has been entered. Press the **Done** softkey to finish editing and the waveform will be saved in the bin file format under the current path.

Generate the Modulated Waveform

Supported modulation types include: AM (Amplitude Modulation), FM (Frequency Modulation), PM (Phase Modulation), PWM (Pulse Width Modulation), ASK (Amplitude Shift Keying), PSK (Phase Shift Keying), FSK (Frequency Shift Keying), 3FSK (ternary frequency shift keying), 4FSK (quadrature frequency shift keying), BPSK (biphase phase shift keying), OSK (oscillating keying), SUM (Sum Modulation), DSB_AM (Double-Sideband Amplitude Modulation).

Press the **Mod** function key, press the **Type** softkey, turn the knob to select the modulation type, and press the **OK** softkey to enter the setup menu. To turn off the modulation, press the **Mod** function button again.

Parameters of modulated waveforms:

Type	Parameters	
AM	Internal source	Shape, AM Frequency, Depth
	External source	

FM	Internal source	Shape, FM Frequency, Deviation
	External source	Deviation
PM	Internal source	Shape, PM Frequency, Phase Deviation
	External source	Phase Deviation
PWM	Internal source	Shape, PWM Frequency, Duty Deviation
	External source	Duty Deviation
ASK	Internal source	ASK Rate, Amplitude
	External source	Slope, Amplitude
PSK	Internal source	PSK Rate, Phase Deviation
	External source	Slope, Phase Deviation
FSK	Internal source	FSK Rate, Hop Frequency
	External source	Slope, Hop Frequency
3FSK	FSK Rate, Hop Frequency 1, Hop Frequency 2	
4FSK	FSK Rate, Hop Frequency 1, Hop Frequency 2, Hop Frequency 3	
BPSK	Bit Rate, Phase Deviation, Data Source	
OSK	Internal source	OSK Rate, Oscillating Time
SUM	Internal source	Shape, AM Frequency, Depth
	External source	
DSB_ AM	Internal source	Shape, AM Frequency
	External source	

Generate Sweep

In the frequency sweep mode, the generator "steps" from the start frequency to the stop frequency at the sweep rate you specify. Sweep can be generated by Sine, Square, Ramp or Arbitrary waveforms.

When the output signal is Sine, Square, Ramp or Arbitrary waveform, press the front panel **Sweep** key to enter the sweep mode (the backlight of the button lights up). The parameters allowed to be set are: Sweep Time, Linear/Log, Start Frequency/Center Frequency, Stop Frequency/Frequency Span, Trigger Source.

Generate Burst

Press the **Burst** key on the front panel to generate versatile waveforms in burst. Burst can last for certain times of waveform cycle (N-Cycle Burst), or to be controlled by external gated signals (Gated Burst). Burst can apply to Sine, Square, Ramp, Pulse and Arbitrary waveforms (Noise can not be used).

Parameters as Burst Period, Cycles/Infinite and Trigger source are allowed to

be set in N-Cycle mode.

Polarity is available in Gated mode.

Counter

The frequency counter measures signals in the frequency range from 100 mHz to 200 MHz. The **[10MHz In/Out/Counter]** connector on the rear panel is used by default to receive the frequency counter input signal. The frequency meter works from the start, unless the connector is set to an external clock input or clock output.

- (1) Press the front panel **Counter** function key to enter the frequency counter interface.
- (2) Connect the signal to be tested to the **[10MHz In/Out/Counter]** connector on the rear panel.
- (3) Set the frequency counter:
 - Press the **Coupling** softkey to switch between AC and DC, to set the coupling mode of the input signal.
 - Press the **Sensitivity** softkey to toggle between Low, Middle or High. For small amplitude signals, the sensitivity is selected to be middle or high. For low frequency large signals or signals with slow rising edges, low sensitivity is selected and the measurement results are more accurate.
 - Press the **HFR** softkey to toggle On or Off high frequency rejection. High-frequency rejection can be used to filter high-frequency factors when measuring low-frequency signals, improving measurement accuracy. When measuring low frequency signals with a frequency less than 1 kHz, turn on high frequency rejection to filter out high frequency noise interference; turn off high frequency rejection when measuring high frequency signals with frequencies greater than 1 kHz.
 - Press the **Trigger Level** softkey. Turn the **knob** to change the current cursor position value, press the arrow keys to move the cursor left or right; or use the **numeric keypad** to enter a value and then select the desired unit from the right menu. The trigger level ranges from -2.5 V to 2.5 V.

After the setting is completed, the frequency counter will measure the signal to be tested at the current setting. If the reading is unstable, repeat the above adjustment until the display is stable.

- (4) The frequency, period, duty cycle, positive pulse width, and negative pulse width can be viewed on the frequency meter interface. If it is not currently in frequency counter interface, the frequency, period and duty cycle can be viewed in the frequency counter bar at the bottom of the screen.

File Store System

The storage location is divided into the internal storage (INTER) and the USB device storage (USBDEVICE). When a USB device is connected, the main interface will show "USBDEVICE" and "INTER". Otherwise, the main interface will show "INTER" only.

The internal memory can store 32 arbitrary waveform data.

Press the front panel **Store** function key to enter the file system.

Save the current arbitrary wave

- (1) Press the  Arbitrary Wave button to enter the Arbitrary Wave menu and configure the waveform parameters.
- (2) Press the front panel **Store** function key to enter the file system.
 - If you want to save the current arbitrary waveform to the internal memory, select **INTER** and press the **Arb file** softkey. Turn the knob to select one of the USER files (EditMemory cannot be selected) and press the **Save** softkey. (The file size is displayed on the right side of the USER file. If 0B is displayed, it means the file is empty.)

Description: EditMemory is a temporary data space created, saved, edited or recalled by any arbitrary wave. Saving the waveform is to save the data of this space to the user-specified location (EditMemory is in the memory and never empty). The data in this space is changed after an arbitrary waveform is called, a new waveform is created, or a related programming command is received.

- If you want to save to a USB storage device, you need to plug the USB storage device into the front panel USB interface. Turn the knob to select **USBDEVICE**. Press the **Arb file** softkey and the instrument will list the directories of the folders and files in the USB storage device. You can turn the knob to select a folder or file. Press the **Enter** softkey

to enter the currently selected folder. To return to the parent directory, press the **Back** softkey. After selecting the storage path, press the **SaveAs** softkey and the input keyboard appears on the screen. Turn the knob to select a character. Press the **ABC/abc** softkey to toggle the case of keyboard characters. Press the **Select** softkey to enter the current character. Press the **Delete** softkey to delete the last character that has been entered. Press the **Done** softkey to finish editing and the waveform will be saved in the bin file format under the current path.

Bring up arbitrary wave files in internal/external memory

Press the front panel **Store** function key to enter the file system.

- To call up the waveform file in the internal memory, select **INTER** under the memory selection interface and press the **Arb file** softkey. Turn the knob to select a file and press the **CallOut** softkey. If the reading is successful, the screen will prompt “File Read Successful”.
- **Description:** The file size is displayed on the right side of the file. If 0B is displayed, the file is empty.
- To recall the waveform file in the USB storage device, turn the knob to select **USBDEVICE** in the memory selection interface. Press the **Arb file** softkey and the instrument will list the directories of the folders and files in the USB storage device. Turn the knob to select a folder or file. Select the file with the suffix of bin and press the **CallOut** softkey. If the reading is successful, the screen will prompt “File Read Successful”.

To copy the waveform file from the USB storage device to internal memory:

- After the waveform file in the USB storage device is called up according to the previous step, press the **Back** softkey to return to the upper directory. After returning to the memory selection interface, turn the knob to select **INTER** and press the **Arb file** softkey. Turn the knob to select a **USER** file and press the **Save** softkey to copy the waveform file to the internal memory.

Description: In the arbitrary waveform interface, Shape displays the storage location or waveform name of the current arbitrary waveform. **USER** indicates the internal memory, **External** indicates the USB storage device, and if it is a built-in waveform, the built-in waveform name is displayed.

Erase waveforms from memory

To erase all waveforms from the instrument internal memory:

- (1) Press the front panel **Store** function key to enter the file system.

- (2) Select **INTER** under the memory selection interface, and then press the **Arb file** softkey.
- (3) Press the **Secure** softkey, the screen pops up, and then press the **OK** softkey to erase all waveforms stored in internal memory.

Save/recall instrument setup

The instrument settings can be saved as files in internal memory. Up to 16 instrument settings can be saved in the instrument internal memory. The saved settings can be restored from files in the internal memory.

Operation Step:

Press the front panel **Store** function key to enter the file system.

- If you want to save the settings to the internal memory, select **INTER** and press the **Set File** softkey. Turn the knob to select a Setup file and press the **Save** softkey. (The file size is displayed on the right side of the Setup file. If 0B is displayed, it means the file is empty.)
- Note: Press the **Secure** softkey, and then press the **OK** softkey to clear all the settings in the internal memory.
- To recall a setup, select the desired setup, and press the **CallOut** softkey.

Utility Setting

Press the front panel **Utility** function key to enter the system options menu. The user can set the display parameters of the signal generator, CH1/2 parameters, interface parameters and system parameters. Press **Utility** again to exit the system options menu.

Utility system menu

Menu	Description
Display Setting	
Backlight	Set the parameter value of the screen brightness
Screen saver	Screen saver time range between 1 to 999 minutes
Separator	Set the separator for the screen display data
Date	Set the current date and time of the system
CH1/2 Setting	
CH1 Sync	Enable/disable front panel CH1 sync output terminal to output sync signal

4.Quick Start

CH2 Sync	Enable/disable front panel CH2 sync output terminal to output sync signal
CH1 Load	It is convenient for the user to match the display voltage with the desired load. The range is from 1 Ω to 10 k Ω
CH2 Load	
I/O Setting	
USB Device	<p>Set the communication protocol type of the USB Device interface on the rear panel.</p> <p>PC: This is the internal communication protocol. Select this option when connecting to the Waveform Editor software running on computer via the USB Device interface.</p> <p>USBTMC: Select this when you need to use the USBTMC communication protocol standard.</p>
Network	Network parameters while communicating with a computer using a LAN interface
System Setting	
Language	Select instrument interface language
Beeper	If On, it makes sounds when prompted
CLK Ref	Internal or External
CLK Output	When the instrument is set to the internal clock reference, it can be switched On or Off . When the selection is On , the rear panel [10MHz In/Out/Counter] connector outputs a 10MHz clock signal.
Update Firmware	The instrument firmware can be updated using a USB storage device through the front panel USB interface.

5. Communicate with PC

Supports communication with a computer via a USB port or a LAN port. Using the Waveform Editor software installed on the computer, the signal generator can be operated on the computer to control the output of the signal generator.

Here's how to connect to a computer. First, install the Waveform Editor software on the CD-ROM on your computer. Then, there are several connection options to choose from.

Using USB Port

- (1) **Set the USB device protocol type of the signal generator:** Press **Utility** → **I/O Setup** → **USBDEV**, switch to PC.
- (2) **Connection:** Connect the USB Device interface on the rear panel of the signal generator to the **USB interface** of the computer with a USB cable.
- (3) **Install the driver:** Run Waveform Editor software on the computer, press F1 to view the built-in help documentation. Follow the instructions to install the driver. The path of the driver is the USBDRV folder in the directory where the Waveform Editor communication software is located, such as "C:\Program Files (x86)\DS_Wave\Waveform Editor\USBDRV".
- (4) **Host computer communication port setting:** Open the Waveform Editor software, click "Communications" in the menu bar, select "Ports-Settings", in the setting dialog box, select the communication port as "USB". After the connection is successful, the connection status prompt in the lower right corner of the software interface turns green.

Using LAN Port

Connect Directly

- (1) **Connection.** Plug one end of the network cable into the LAN connector on the rear panel of the signal generator; the other end is plugged into the LAN interface of the computer.
- (2) **Set the network parameters of the computer.** Since the signal generator does not support automatic IP address acquisition, you need to specify the IP yourself. Here we set the IP address to 192.168.1.71.
- (3) **Set the network parameters of the host computer.** Run Waveform Editor software on the computer. In the "Communications" menu, under "Ports-Settings", select the communication port as "LAN", the IP is set to be the same as the first three fields of the computer's network IP in step (2), and the

last field has a different IP address. It is "192.168.1.99"; the port can be set to any value from 0 to 4000. However, since ports below 2000 are often occupied, it is recommended to set it to 2000 or higher. Here, it is set to "3000".

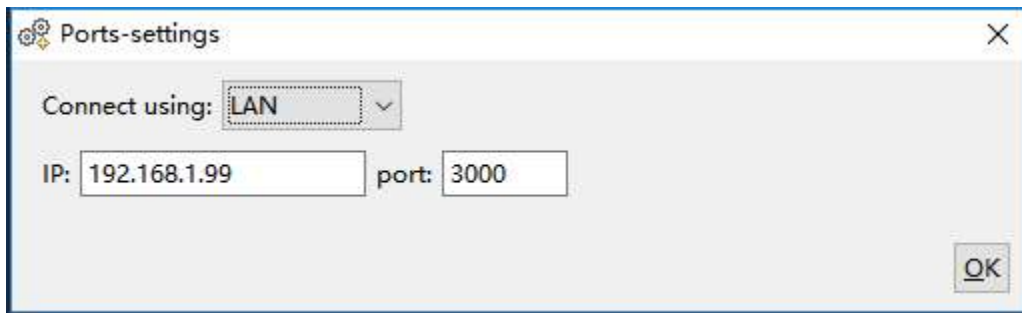

Figure 5-1: Setting the network parameters of the host computer

- (4) **Set the network parameters of the signal generator.** In the signal generator, press **Utility** → **I/O Setup** → **Network setting** to enter the submenu. Set the IP address and port to the IP and port in the PC software port settings in step (3). After the shutdown and restart, if the data can be obtained normally in the PC software, the connection is successful.

Connect through a Router

- (1) **Connection.** Connect the LAN interface on the rear panel of the signal generator to the router with a network cable. The computer is also connected to the router.
- (2) **Set the network parameters of the computer.** Since the signal generator does not support automatic IP address acquisition, you need to specify the IP yourself. The default gateway and subnet mask settings must match the settings of the router. For example, the IP address is set to 192.168.1.71, the subnet mask is set to 255.255.255.0, and the default gateway is set to 192.168.1.1.
- (3) **Set the network parameters of the host computer.** Run Waveform Editor software on the computer. In the "Communications" menu, under "Ports-Settings", select the communication port as "LAN", the IP is set to be the same as the first three fields of the computer's network IP in step (2), and the last field has a different IP address. It is "192.168.1.99"; the port can be set to any value from 0 to 4000. However, since ports below 2000 are often occupied, it is recommended to set it to 2000 or higher. Here, it is set to "3000".

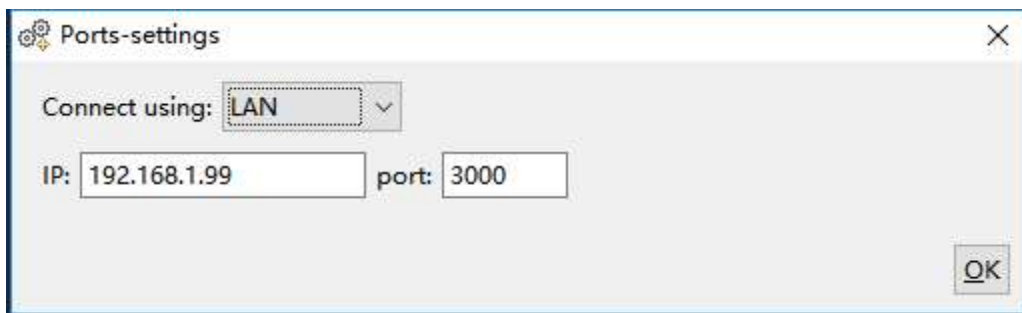

Figure 5-1 : Set the network parameters of the host computer

- (4) **Set the network parameters of the signal generator.** In the signal generator, press **Utility** → **I/O Setup** → **Network setting** to enter the submenu. Set the IP address and port to the IP and port in the PC software port settings in step (3). The gateway settings need to be the same as the gateway settings of the router. After the shutdown and restart, if the data can be obtained normally in the PC software, the connection is successful.

For the specific operation method of Waveform Editor software, please press F1 to view the built-in help documentation.

6. Appendix

Appendix A: Accessories

- 1 × power cord that meets the standards of the country where you are located
- 1 × USB communication cable
- 1 × CD with communication software
- 1 × Quick Guide
- 2 × BNC/Q9 cable

Appendix B: General Care and Cleaning

General Maintenance

Do not store or leave the instrument where the liquid crystal display will be exposed to direct sunlight for long periods of time.

Caution: To avoid any damage to the instrument or probe, do not exposed it to any sprays, liquids, or solvents.

Cleaning

Inspect the instrument and probes as often as operating conditions require. To clean the instrument exterior, perform the following steps:

1. Wipe the dust from the instrument and probe surface with a soft cloth. Do not make any scuffing on the transparent LCD protection screen when clean the LCD screen.
2. Disconnect power before cleaning your instrument. Clean the instrument with a wet soft cloth not dripping water. It is recommended to scrub with soft detergent or fresh water. To avoid damage to the instrument or probe, do not use any corrosive chemical cleaning agent

 **Warning:** Before power on again for operation, it is required to confirm that the instrument has already been dried completely, avoiding any electrical short circuit or bodily injury resulting from the moisture.
