

SUMMARY

Wires

Low	6
High	0
Coax	0
Triax	0
Quad	0
Fiber	0
Fluidic	0



Image is for illustrative purpose only

Series

Termination type	Male solder
IP rating	50
Cable Ø	5.30 - 6.20 mm
Matching parts	EGG.1B.306.CLL
Status	active

Alternative part

TECHNICAL DETAILS

Mechanics

Shell Style/Model	FG*: Straight plug, cable collet
Keying	1 key (alpha=0, plug: male contacts, receptacle: female contacts)
Housing Material	Brass (chrome plated) shell and collet nut, nickel plated brass latch sleeve and mid pieces
Cable Fixing	D62: 5.3 - 6.2 mm
Variant	

Performance

Configuration	1B.306 : 6 Low Voltage
Insulator	L: PEEK (UL 94 / V-0/3.2, depends on material thickness)
Rated Current	7 Amps

Specifications

Contact Type: Solder
Max. Matings: 5000
Contact Dia.: 0.7 mm (0.028in)

LEMO products and services are provided "as is". LEMO makes no warranties or representations with regard to LEMO product & services or use of them, express, implied or statutory, including for accuracy, completeness, or security. The user is fully responsible for his products and applications using LEMO components.

Bucket Dia.: 0.8 mm (0.031in)
 Max. Stranded Conductor: 0.34 mm² (AWG 22)
 Max. Conductor: 0.34 mm² (AWG 22)
 R (max): 6.1 mOhm
 Vtest (contact-shell): 1200 V (AC), 1700 V (DC)
 Vtest (contact-contact): 1050 V (AC), 1490 V (DC)

Others

Temp (min / max): -55° C / +250° C
 Humidity (max): <=95% [at 60 deg C /140 F]
 Vibration: 15 g [10 Hz - 2000 Hz]
 Shock Resistance: 100 g [6 ms]
 Salt Spray Corrosion: >1000 hr
 Climatical Category: 50/175/21
 Shielding (min): 75 dB (10 MHz)
 Shielding (min): 40 dB (1 GHz)
 IP Rating: 50

DRAWINGS

Draws

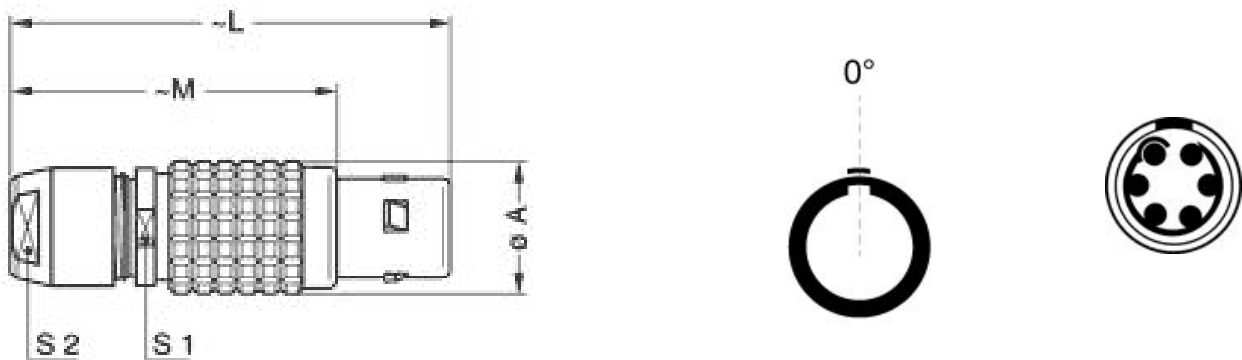

Dimensions

	A	L	M	S1	S2
mm.	12	43	32	10	9
in.	0,47	1,69	1,26	0,39	0,35







RECOMMENDED BY LEMO

LEMO products and services are provided "as is". LEMO makes no warranties or representations with regard to LEMO product & services or use of them, express, implied or statutory, including for accuracy, completeness, or security. The user is fully responsible for his products and applications using LEMO components.

Tools

Spanner wrench: DCD.1B.015.PA090
Caps: BFG.1B.100.PCSG

Cables

CMN.06.T22.055PGCE	PVC	GREY	
CMN.06.T22.055PGZE		Grey	
CMN.06.T22.055PNCE	PVC	Black	
CMN.06.T22.055PNZE			
012 080	PVC	Grey	
106 220	PVC	Black	
160 240	PVC	Black	
260 250	PVC	Grey	

LEMO products and services are provided "as is". LEMO makes no warranties or representations with regard to LEMO product & services or use of them, express, implied or statutory, including for accuracy, completeness, or security. The user is fully responsible for his products and applications using LEMO components.